

RANE SIXTY-TWO MIXER MANUAL

Important Safety Instructions

1. Read these instructions.
 2. Keep these instructions.
 3. Heed all warnings.
 4. Follow all instructions.
 5. Do not use this apparatus near water.
 6. Clean only with a dry cloth.
 7. Do not block any ventilation openings. Install in accordance with manufacturer's instructions.
 8. Do not install near any heat sources such as radiators, registers, stoves, or other apparatus (including amplifiers) that produce heat.
 9. Do not defeat the safety purpose of the polarized or grounding type plug. A polarized plug has two blades with one wider than the other. A grounding-type plug has two blades and a third grounding prong. The wide blade or third prong is provided for your safety. If the provided plug does not fit into your outlet, consult an electrician for replacement of the obsolete outlet.
 10. Protect the power cord and plug from being walked on or pinched particularly at plugs, convenience receptacles, and the point where it exits from the apparatus.
 11. Only use attachments & accessories specified by Rane.
 12. Use only with the cart, stand, tripod, bracket, or table specified by the manufacturer, or sold with the apparatus. When a cart is used, use caution when moving the cart/apparatus combination to avoid injury from tip-over.
 13. Unplug this apparatus during lightning storms or when unused for long periods of time.
 14. Refer all servicing to qualified service personnel. Servicing is required when the apparatus has been damaged in any way, such as power supply cord or plug is damaged, liquid has been spilled or objects have fallen into the apparatus, the apparatus has been exposed to rain or moisture, does not operate normally, or has been dropped.
 15. The plug on the power cord is the AC mains disconnect device and must remain readily operable. To completely disconnect this apparatus from the AC mains, disconnect the power supply cord plug from the AC receptacle.
 16. This apparatus shall be connected to a mains socket outlet with a protective earthing connection.
 17. When permanently connected, an all-pole mains switch with a contact separation of at least 3 mm in each pole shall be incorporated in the electrical installation of the building.
 18. If rack-mounting, provide adequate ventilation. Equipment may be located above or below this apparatus, but some equipment (like large power amplifiers) may cause an unacceptable amount of hum or may generate too much heat and degrade the performance of this apparatus.
- WARNING:** To reduce the risk of fire or electric shock, do not expose this apparatus to rain or moisture. Apparatus shall not be exposed to dripping or splashing and no objects filled with liquids, such as vases, shall be placed on the apparatus.

Warning



To reduce the risk of electrical shock, do not open the unit. No user serviceable parts inside. Refer servicing to qualified service personnel. The symbols shown below are internationally accepted symbols that warn of potential hazards with electrical products.



This symbol indicates that there are important operating and maintenance instructions in the literature accompanying this unit.



This symbol indicates that a dangerous voltage constituting a risk of electric shock is present within this unit.

These stickers are located on the bottom of the mixer.

WARNING: This product may contain chemicals known to the State of California to cause cancer, or birth defects or other reproductive harm.

FCC Statement

This equipment has been tested and found to comply with the limits for a Class B digital device, pursuant to part 15 of the FCC Rules. These limits are designed to provide reasonable protection against harmful interference in a residential installation. This equipment generates, uses and can radiate radio frequency energy and, if not installed and used in accordance with the instructions, may cause harmful interference to radio communications. However, there is no guarantee that interference will not occur in a particular installation. If this equipment does cause harmful interference to radio or television reception, which can be determined by turning the equipment off and on, the user is encouraged to try to correct the interference by one or more of the following measures:

- Reorient or relocate the receiving antenna.
- Increase the separation between the equipment and receiver.
- Connect the equipment into an outlet on a circuit different from that to which the receiver is connected.
- Consult the dealer or an experienced radio/TV technician for help.

CAUTION: Changes or modifications not expressly approved by Rane Corporation could void the user's authority to operate the equipment.

This Class B digital apparatus complies with Canadian ICES-003.

Cet appareil numérique de la classe B est conforme à la norme NMB-003 du Canada.

Copyright Notices

©2014 Rane Corporation. All rights reserved. Serato DJ and Scratch Live are trademarks of Serato. Trademarked in the United States and other countries. This software is based in part on the work of the Independent JPEG Group, and uses libpng code, copyright © 2000-2002 Glenn Randers-Pehrson. The Serato NoiseMap™ Control Tone, the audio pressed on Serato Control vinyl and Control CDs, is copyright ©2004-2014 Serato. The Control Vinyl and Control CDs are licensed for personal use only. The creation of personal backups of the Control CD is allowed, however duplicating Control CDs for commercial benefit is strictly prohibited. For avoidance of doubt the duplication or creation of Control vinyl for any use is strictly prohibited. Please respect our copyright. Windows® is a registered trademark of Microsoft Corporation in the United States and other countries. Apple, Mac, Macintosh, iTunes, Safari, QuickTime, GarageBand, and OS X are registered trademarks of Apple Inc., registered in the United States and other countries.

Check List

These items are included in the box:

- **1 Sixty-Two Mixer.**
- **Serato DJ software and drivers install disc.**
- **2 (two) control CDs.**
- **2 (two) control records.**
- **2 USB cables.**
- **IEC C5 line cord.**
- **Serato DJ Software Manual.**
- **This Sixty-Two Mixer Manual.**

Wear Parts

The Sixty-Two Mixer contains no wear parts. The control vinyl records and CDs are wear parts as described in "Limited Warranties" on page 39.

Contents

2 Important Safety Instructions

3 Check List

5 Quick Start: Software

6 Quick Start: Hardware

9 Sixty-Two Overview

10 Sixty-Two Connections

- 10 Power Supply
- 10 Analog Inputs
- 10 Analog Outputs
- 11 Two USB Ports

12 Deck Input Channels

- 12 Source Selector
- 12 Level
- 12 Pan
- 12 Tone Controls
- 13 Filter
- 13 FlexFX
- 13 Channel Faders & Crossfader
- 13 Channel Meters
- 13 Headphone Cue

13  Aux

14 Session In and Out

14 Main and Booth

14 Software Controls

- 14 Library Browse
- 15 Loops Manual / Auto
- 15 Manual Loop Controls
- 15 Auto Loop Controls
- 15 Cues / Samples control
- 15 Cue Points
- 16 Sample Player (SP-6) Triggers

16 FlexFX Loop

- 17 Internal Audio Effects
- 17 Echo Effects
- 19 Effects Parameter Table

20 Shift Options

- 20 Ext. Insert Options Menu
- 20 Filter Effect Options Menu
- 20 Flanger Effect Options Menu
- 20 Echo Effect Options Menu
- 21 Deck 1-2 Channel Options Menu
- 21 Mic Option Menu
- 21 Mic Bypass Mode
- 21 Headphone Tone Control
- 22 Mixer Shift Functions
- 22 MIDI Start/Stop
- 22 Nudge
- 22 BPM Adjust
- 22 Sync
- 22 Slip

23 DJ Changeover

24 Driver Control Panel

26 Factory Defaults

27 MIDI Mapping

30 MIDI Implementation

32 MIDI Control Change Chart

34 Magnetic Fader Maintenance

36 Technical Specifications

37 Battle Bridge Accessory

38 Declaration of Conformity

39 Limited Warranties

Quick Start: Software

Before using your Sixty-Two, at least read this short section for the basics. Read the complete manual to get the best investment from your new Sixty-Two. This section will help get you started with one computer.

Serato DJ Software Installation for Mac OSX

Before installing, we recommend you check for a newer version of Serato DJ at serato.com/downloads and install the latest Serato DJ version if it is newer than the version on the CD-ROM that comes with your mixer.



1. Insert the Serato DJ Installer CD-ROM that came with your unit,
-or-
browse using Finder to the location where the Serato DJ download was saved.
2. Double click the Serato DJ .dmg installer file.
3. The software EULA screen will appear - read the License Agreement, then click Agree.
4. The disk image mounts and opens the actions folder, once this is finished you can unmount the disk image and launch Serato DJ.
5. Drag the Serato DJ application icon to the Applications folder alias.
6. You may then need to enter your User Password to authenticate.
7. Serato DJ will now copy to the Applications folder, once this is finished you can unmount the disk image and launch Serato DJ.

Serato DJ Software Installation for Windows

Before installing, we recommend you download and install the latest Serato DJ version from serato.com if it is newer than the version on the CD-ROM that comes with your mixer.

1. Insert the Serato DJ Installer CD-ROM that came with your unit,
-or-
browse using Windows Explorer to the location where the Serato DJ download installer was saved.
 2. Double click the Serato DJ .exe installer file.
 3. Accept the Security Warning and click "Run".
 4. The installer introduction screen will appear, click Next.
 5. Read the License Agreement, then tick "I agree to the license terms and conditions," then click Install.
 6. If a User Account Control window appears, click Yes.
 7. Serato DJ will now perform a standard installation.
 8. The installation is now complete. You can now click Close.
- NOTE: A shortcut will be also be created on desktop.

When you first connect your Sixty-Two Mixer via USB, you may see a request to install drivers. Accept the request and allow the driver installation to proceed. After drivers are installed, a Sixty-Two control panel will be available, and your software will recognize the Sixty-Two.

After Serato DJ is installed, you will be prompted to "Install Driver" in the Online Panel if you connect a new compatible device that has not already had its driver installed.

Serato Scratch Live

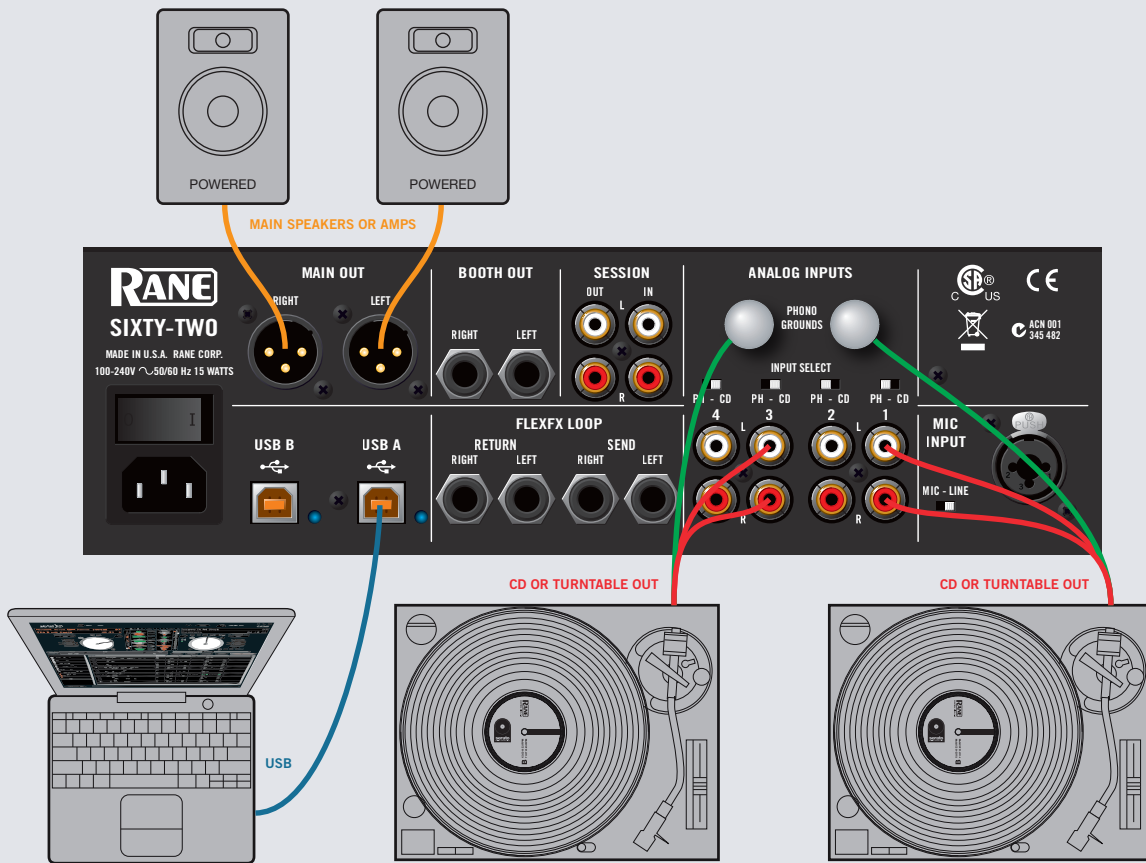

Your Sixty-Two is also completely compatible with Serato Scratch Live. You may connect to a laptop that has either program installed. **If you would like to continue using Scratch Live, you can download the Sixty-Two Manual for Serato Scratch Live at either serato.com or dj.rane.com.**



Quick Start: Hardware

This guide will help you get your decks connected and music playing on one computer. Leave the power off until your decks and amplifiers are connected.

Analog Inputs

1. Connect your Left deck's RCA cables to **ANALOG INPUT 1**.
 - If it's a CD player, select **CD** with the switch above the input jacks.
 - If it's a turntable, select **PH** (Phono) with the switch above the input jacks. Secure the ground wire to a Phono Ground terminal.
2. Set the **SOURCE** selector for **DECK 1**.
 - PH / CD 1** plays directly from your deck.
 - To play from Serato DJ or Scratch Live, choose  **A**.
3. Connect your Right deck's RCA cables to **ANALOG INPUT 3**.
 - Select **CD** or **PH** as in step 1.
4. Set the **SOURCE** selector for **DECK 2**.
 - PH / CD 3** plays directly from your deck.
 - To play from Serato DJ or Scratch Live, choose  **A**.

Analog Outputs

- **Main Out** is on a pair of balanced XLR jacks with pin 2 “hot” per AES standards.
- **Booth Out** is on a pair of balanced ¼” TRS (tip-ring-sleeve) jacks.
- **Session Out** is available on a pair of unbalanced RCA jacks.
- **Headphones** output mix is available on both ¼” and 3.5 mm jacks.

The Main, Booth and Session outputs arrive from the same “Main Mix” signal. Main, Booth and Session outputs each have their own **LEVEL** control. Because all signals are identical, you may use any of these outputs as the “Main” output if a different cable type is required to your speaker amplifiers.

Rane recommends balanced wiring (3-conductor) for the strongest signal and rejection of hum and noise. If your cable to the destination is less than 10 feet (3 meters), you can often get away with an unbalanced cable. See the RaneNote “[Sound System Interconnection](#)” at [rane.com](#) for cable wiring recommendations.

Quick Start: Operation

USB Control Source

The default Inputs for decks performing Digital Vinyl Simulation (DVS) are Inputs 1 and 3, but you can change this. Analog Input 1 or 2 may be selected in Serato DJ software as the DVS signal for the Left Virtual Deck. Analog Input 3 or 4 may be selected in software as the DVS signal for the Right Virtual Deck.

To select the control sources in Serato DJ, click the SETUP button at the top of the screen. In the Audio tab, verify that Control Source > PGM 1 is set to “1”. This will be your Left Virtual Deck. verify that Control Source > PGM 2 is set to “3”. This will be your Right Virtual Deck.

To select the control sources in Scratch Live, click the SETUP button at the top of the Scratch Live screen. In the Hardware > General tab, verify that Control Source > PGM 1 is set to “1”. This will be your Left Virtual Deck. verify that Control Source > PGM 2 is set to “3”. This will be your Right Virtual Deck.

Calibrating Serato DJ for Control Vinyl or CD

Since Serato DJ is controlled by an analog signal, there is no guarantee of what state that signal will be in by the time the software gets to interpret it. Therefore, Serato DJ needs to be able to handle a wide range of signals, and be configurable to use them optimally. Calibrating is just configuring the software to your situation. Calibration is equally important for both vinyl and CD users of Serato DJ.

There are two parts to the Serato DJ Control Vinyl: The directional tone, and the NoiseMap™. Listening to the control vinyl, the directional tone is the 1 kHz tone. The noise map sounds like random noise over the top of the tone. The directional tone provides the current speed and direction of the record, while the noise map tells the software precisely where on the record the needle is currently.

The Noise Sensitivity slider lets you adjust the noise threshold. A threshold is a lower limit, below which a process will not occur. In the case of Serato DJ, the noise threshold is the limit below which the input signal will not be interpreted as control signal; in other words if it's below the threshold, it is considered noise and ignored.

This setting is necessary because a stylus is very sensitive, and will inevitably pick up noise from the environment as well as the signal on the record, especially in the noisy environment of a live show.

How To Calibrate Serato DJ

With music playing in the background through your system or booth output, put your needle on the record with the turntable stopped. If you are using CD players, the same rules apply. Have the CD deck paused or stopped while calibrating.

Click and hold the estimate button until the slider stops moving. Moving the Noise Sensitivity slider to the left will make Serato DJ more sensitive to slow record movement, but also more sensitive to background noise.

Repeat the process for each deck.

Things to remember:

- Your needle must be on the record.
- Your turntable (or CD player) must be stationary.
- The background music playing must be at a similar level to which you will play your set at.
- Calibrate Serato DJ every time you play.

TIP: If the slider jumps to the far right, then you have a problem with noise in your turntables/CD players/mixer. Check all your connections and make sure your equipment is well earthed. In some situations you will not be able to improve the signal quality, and you will have to play on regardless. In this situation, stick to **rel** mode.

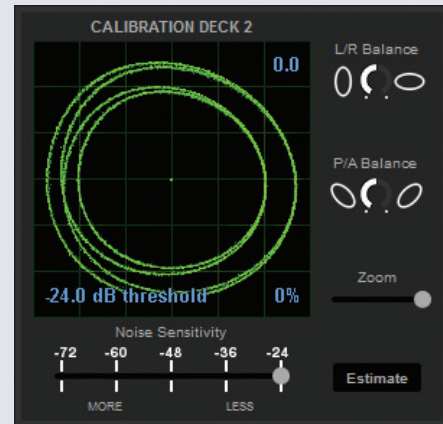

The Scopes

The scopes on the setup screen in Serato DJ display the input signal as a phase diagram. The key factors to look at on the scope display are crisp clean lines, round shape, and the tracking percentage in the lower right corner.

Start both turntables or CD players. You will see green rings appear in the scope view, as shown above.

For optimal performance the inner ring should be as close to circular as possible. Use the scope zoom slider to zoom in or out as necessary. Use the scope L/R balance and P/A balance controls to adjust the shape of the inner ring. The number in the top left corner of the scope view gives the current absolute position within the control record or CD. The number in the top right corner is the current speed in RPM. In the bottom left is the current threshold setting, and the number in the bottom right shows the percentage of readable signal – this number should be close to 85% when your system is calibrated properly.

For complete software operating instructions, see the Serato DJ Manual.

Sixty-Two Overview

Software controls are built-in for one or two computers

- Includes Serato DJ software.
 - Includes Rane ASIO and Core Audio Drivers for Serato DJ and other audio programs.
- Advanced MIDI and audio routing: route either deck to either USB Port, and MIDI follows the audio.
- Independently control Library, Cues, Loops and Samples on two computers with more than 40 software controls.
- Each of the two USB ports supports six stereo record and four stereo playback channels.
- USB record channels support:
 - Vinyl control signal for two Virtual Decks, or record either of Decks post-fader.
 - Record the Main Mix or the Mic.
 - FlexFX USB Insert Send to each computer.
- USB playback channels support:
 - Playback for two Virtual Decks.
 - USB Aux playback for the SP-6 sample player.
 - FlexFX USB Insert Return from each computer.
- Great-sounding 32-bit floating-point audio sampled at 48 kHz.

Deck input channel controls

- Pre-fader Level, 3-band isolator EQ, plus low-pass / high-pass sweep Filter with resonance adjustment.
- Crossfader, FlexFX and headphone Cue assigns.
- Proprietary magnetic faders and crossfader with contour and reverse controls.

Mic input

- Mic / Line input level switch.
- Controls: On, Over, Level, 2-band Tone and FlexFX assign.
- Unused Mic controls easily map to MIDI.

Advanced post-fader FlexFX

- Internal Effects engine with:
 - Filter, Flanger, Phaser, Echo, Robot and Reverb.
 - MIDI beat clock tracking and generation.
 - Sync BPM with Serato DJ, MIDI beat clock or manual Tap button.
- USB Insert loop for post-fader software effects for each of the two ports.
- External analog insert loop for outboard effect units.

Main Mix section

- Balanced XLR Main Mix and 1/4" TRS Booth outputs.
- RCA analog Session In & Out.

Headphone monitor with split cueing.



Sixty-Two Connections

Power Supply

This mixer features an internal universal switching power supply that operates on any AC mains 100 to 240 VAC, 50 or 60 Hz (most places in the world). The universal supply is a major plus for the traveling DJ, who only needs the right IEC line cord, available from a local electronics store. Though this mixer has turn on/off muting, it's smart to leave the power unplugged until everything else is connected.

Analog Inputs

Four Phono / CD inputs are provided by RCA jacks. These may be set for **PH** or **CD** using rear panel slide switches. Analog inputs 1 and 2 are used by **DECK 1**. Analog inputs 3 and 4 are used by **DECK 2**. Analog Input 1 or 2 may be selected in Serato DJ software as the Digital Vinyl Simulation (DVS) signal for the Left Virtual Deck or for recording on USB stereo pair 5-6. Analog Input 3 or 4 may be selected in software as the DVS signal for the Right Virtual Deck or for recording on USB stereo pair 7-8. Set any unused inputs to **CD**. Connect your turntable ground wires to the **PHONO GROUND** posts on the rear when using **PH** inputs.

One stereo Session Input is available on a pair of RCA input jacks. This input may connect two mixers together or as a general purpose auxiliary input to the mixer.

The Mic Input will accept an XLR 3-pin plug, a balanced 1/4" TRS (tip-ring-sleeve) plug or an unbalanced TS (tip-sleeve) plug. This input may be set for Microphone or Line level using the **MIC - LINE** switch on the rear panel. Set this to Line when connecting a wireless receiver.

A stereo FlexFX Loop Return input is on unbalanced 1/4" TS (tip-sleeve) jacks. These inputs automatically switch to mono when only one cable is connected to the left or right Return input. The FlexFX Return input is normally used along with the FlexFX Send output to connect an outboard analog effects processor.

Phono Sensitivity and Analog Insert level can be adjusted in the "Driver Control Panel" on page 24.

Analog Outputs

There are five stereo analog outputs available on the mixer:

- **MAIN OUT** is on a pair of balanced XLR jacks with pin 2 "hot" per AES standards.
- **BOOTH OUT** is on a pair of balanced 1/4" TRS jacks.
- **SESSION OUT** is available on a pair of unbalanced RCA jacks.
- **FLEXFX LOOP SEND** output is available on a pair of unbalanced 1/4" inch TS jacks. For a mono FlexFX Send, use the **Left** output. The FlexFX Send output is normally used along with the **FLEXFX LOOP RETURN** input to connect outboard effects.
- **HEADPHONES** output is available on both 1/4" TRS and 3.5 mm jacks.

The Main, Booth and Session outputs arrive from the same "Main Mix" signal. Main, Booth and Session outputs each have their own **LEVEL** control. Because all signals are identical, users may use any of these outputs as the "Main" output if a different cable type is required for system connection.

Rane recommends balanced wiring for the strongest signal and rejection of hum and noise. If your cable to the destination is less than 10 feet (3 meters), you can often get away with an unbalanced cable. See the RaneNote "[Sound System Interconnection](http://www.rane.com)" at rane.com for cable wiring recommendations.

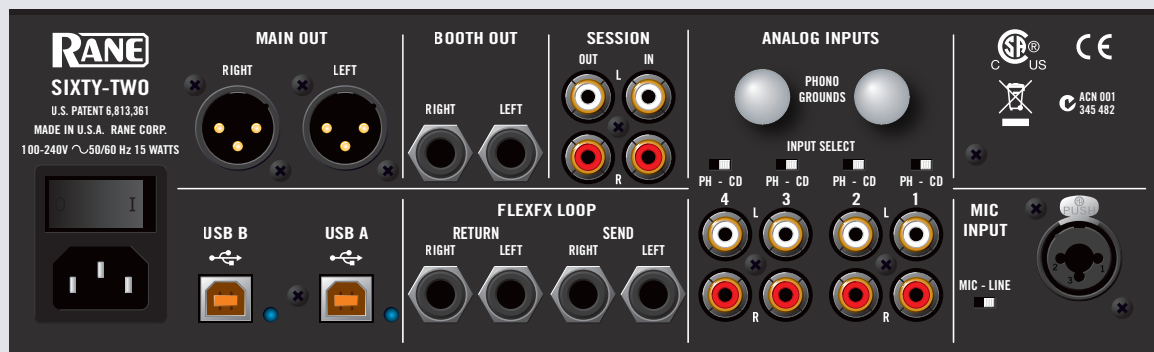

Two USB Ports

There are six stereo record channels and four stereo playback channels. These channels are simultaneously available on two USB ports, allowing two computers to share the device. This allows two DJs to play together and supports uninterrupted transitions from one DJ to another.

Rane ASIO and Core Audio drivers allow the Sixty-Two to act as a 12-record 8-playback USB sound card for use with Serato DJ and other third-party software applications that support ASIO or Core Audio. These drivers are multi-client, meaning they allow multiple applications on a computer to share the device at the same time.

The Sixty-Two has two USB ports, allowing simultaneous connection of two computers. Each port is completely independent. It is possible to run Serato DJ on one computer while running third-party software on the other, Mac or PC. See how to share the Sixty-Two in "DJ Changeover" on page 23.

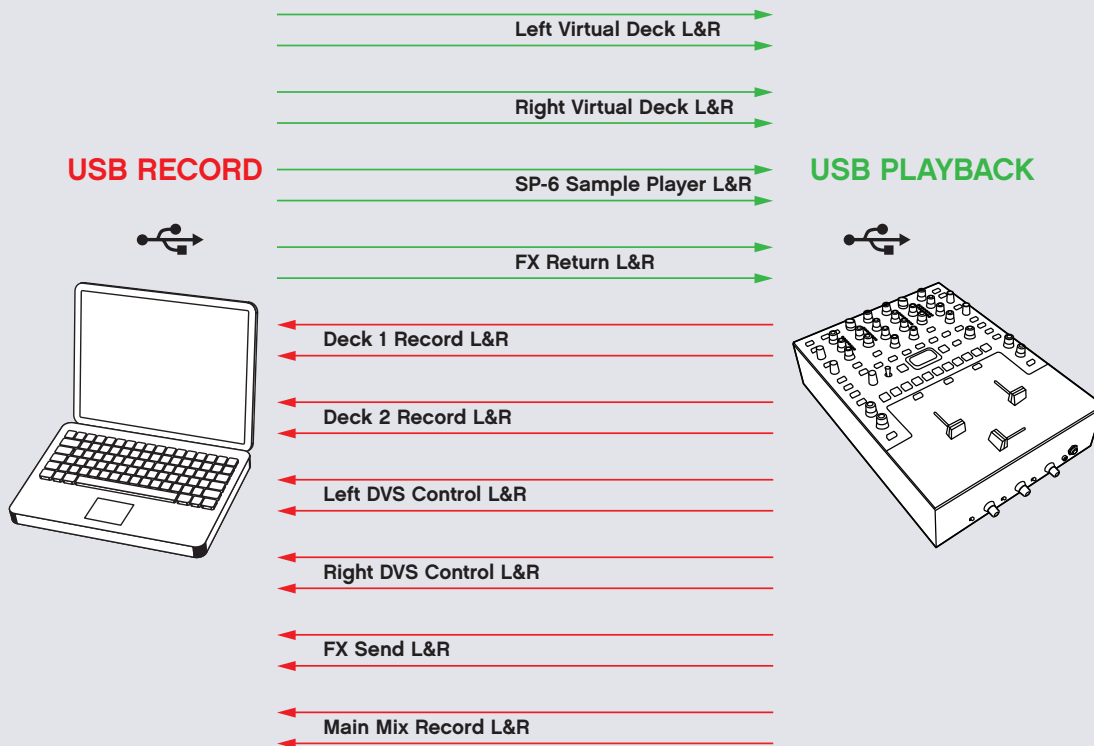

USB Playback	Stereo Pair	Serato DJ Description	Mixer Use
1	1-2	Left Virtual Deck Output	Select as Deck 1 Source from USB A or USB B
2	3-4	Right Virtual Deck Output	Select as Deck 2 Source from USB A or USB B
3	5-6	SP-6 Output Option	USB AUX Source (sum of USB A & USB B)
4	7-8	FX Return to the Mixer	FlexFX Insert Return (sum of USB A & USB B)
USB Record			
1	1-2	Record Source Deck 1	Deck 1 Post Fader and Post Crossfader Output
2	3-4	Record Source Deck 2	Deck 2 Post Fader and Post Crossfader Output
3	5-6	Record or DVS Control for Left Deck	Selects PH/CD 1 or PH/CD 2 in Control Panel
4	7-8	Record or DVS Control for Right Deck	Selects PH/CD 3 or PH/CD 4 in Control Panel
5	9-10	FX Send from the Mixer	FlexFX Insert Send
6	11-12	Record the Main Mix or Mic	Select Main Mix or Mic in the Control Panel

Deck Input Channels

Two input channels, or buses, have nearly identical controls with the exception of the Source selectors.

Source Selector

The **SOURCE** selector for Deck 1 selects one of four sources:

- **A** Left Virtual Deck (USB stereo playback pair 1-2) from USB A.
 - Also assigns the MIDI controls for the Left Deck software and Deck 1 mixer to USB A.
- **PH / CD 1 (THRU)**: Set to **PH** or **CD** on the rear panel.
 - When selected in software, this input is available on USB record 5-6 for use as the DVS control signal or for audio recording. To select this control source in Serato DJ: go to Setup > Audio > Deck Setup > PGM 1 and select "1".
- **PH / CD 2 (THRU)**: Set to **PH** or **CD** on the rear panel.
 - When selected in software, this input is available on USB record 5-6 for use as the DVS control signal or for audio recording. To select this control source in Serato DJ: go to Setup > Audio > Deck Setup > PGM 1 and select "2".



- **B** Left Virtual Deck (USB stereo playback pair 1-2) from USB B.
 - Also assigns the MIDI controls for the Left Deck software and Deck 1 mixer to USB B.

The **SOURCE** selector for Deck 2 selects one of four sources:

- **A** Right Virtual Deck (USB stereo playback pair 3-4) from USB A.
 - Also assigns the MIDI controls for the Right Deck software and Deck 2 mixer to USB A.
- **PH / CD 3 (THRU)**: Set to **PH** or **CD** with the rear panel switch.
 - When selected in software, this input is available on USB record 7-8 for use as the DVS control signal or for audio recording. To select this control source in Serato DJ: go to Setup > Audio > Deck Setup > PGM 1 and select "3".
- **PH / CD 4 (THRU)**: Set to **PH** or **CD** with the rear panel switch.
 - When selected in software, this input is available on USB record 7-8 for use as the DVS control signal or for audio recording. To select this control source in Serato DJ: go to Setup > Audio > Deck Setup > PGM 1 and select "4".
- **B** Right Virtual Deck (USB stereo playback pair 3-4) from USB B.
 - Also assigns the MIDI controls for the Left Deck software and Deck 2 mixer to USB B.

Level

LEVEL controls adjust the input gain from off to +15 dB. Unity gain (no boost or cut) is at 12 o'clock.

Pan

Left / Right **PAN** controls adjust the balance of left and right signals. Left and right are equal at 12 o'clock .

Tone Controls

HIGH, **MID** and **LOW** full-cut isolator tone controls adjust the frequency response from off to +6 dB. Unity gain (no boost or cut) is at 12 o'clock.

Filter

The **FILTER** sweeps from Low-Pass to High-Pass. Set it to 12 o'clock for a flat "no-filter" response. Moving the filter toward the **LOW** position progressively reduces high frequencies. Moving the filter toward the **HIGH** position progressively reduces low frequencies. The Resonance or Q of these Filters can be adjusted on the mixer in the "Deck 1-2 Channel Options Menu" on page 21, or in the "Driver Control Panel" on page 24. High resonance adds a "zip" effect to the Filter when it is moved. Low resonance is best when the Filter is used for mixing.

FlexFX

The blue **FLEXFX** buttons assign an input to the FlexFX bus where internal, external analog or software effects via USB may be inserted. Any combination of Deck 1, Deck 2, Mic or USB Aux can be assigned with the option to insert internal effects, external analog effects or software effects via USB. See "FlexFX Loop" on page 16.

Channel Faders & Crossfader

These faders use magnetic non-contact mechanisms with no noise and no bleed. Each fader has **REVERSE** and **CONTOUR** controls on the front panel. See "Magnetic Fader Maintenance" on page 34.

Channel Meters

Each Deck channel has a mono meter to assist in setting levels. These meters are quasi-peak with peak hold. Use the **LEVEL** controls to stay out of the red.

Headphone Cue

CUE buttons assign a signal to the headphone monitor. Deck 1, Deck 2, USB Aux, and the FlexFX Bus can be cued in the headphones before bringing it into the mix. Cue controls operate as solo or radio-button controls. This means engaging a Headphone Cue turns all the other Headphone Cue controls off. You can select more than one at a time by simultaneously pressing more than one Cue.

- The Headphone monitor provides stereo or mono split cue operation.
 - When set for stereo operation (**SPLIT CUE** dim), the Pan control pans between stereo Cue and stereo Main Mix.
 - When set for Split Cue operation (**SPLIT CUE** bright), the Pan control pans between Mono Cue in the left ear and mono Main Mix in the right ear.
- The Phones **LEVEL** control sets the volume to the headphone jacks.
- Headphone outputs are from ¼" and 3.5 mm jacks on the front panel. Both share the same mix.

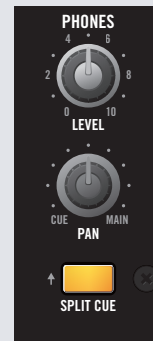



Aux

This digital input is on USB playback stereo pair 5-6 and is normally used for the Serato DJ SP-6 Sample Player.

To enable the SP-6, go to Setup > Expansion Packs > SP-6 Sample Player and check the box for "Enable SP-6 Sample Player."

To assign the SP-6 Sample Player to  **AUX**, click the SP-6 tab at the top of the main software screen and select SP-6 Output as "A."

This  **AUX** input has its own **LEVEL**, **FILTER** and **FLEXFX** assign. **CUE** for  **AUX** is in the center just below the **SAMPLES** row of buttons.

The Resonance for the  **AUX FILTER** can be adjusted in the "Driver Control Panel" on page 24.





Mic Input

This Mic input on a XLR/TRS combo jack has **LEVEL**, **HIGH** and **LOW** tone controls, **FLEXFX** assign and a meter. Select **MIC** or **LINE** level using the rear panel switch. **LINE** is usually correct for wireless mic receivers.

- **MIC ON** turns the mic input on without ducking other inputs.
- **MIC OVER** momentarily turns the microphone on, and ducks other inputs by 10 dB (by about 1/3). Releasing this button turns the mic off.
- The mic section has options for recording and MIDI. See "Shift Options" on page 20.

Session In and Out

The **SESSION IN** has its own level control and may be used as a general purpose analog stereo AUX input from RCA jacks. **SESSION IN** and **SESSION OUT** are typically used to chain mixers together, though any line-level device may be connected to the Session Input and mixed here.

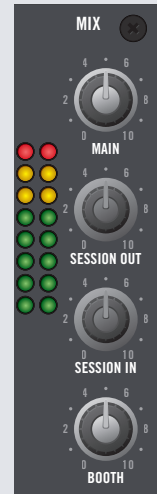

Main and Booth

The Main and Booth outputs each have their own **LEVEL** control. The Main outputs use balanced XLR connectors and the Booth outputs use balanced 1/4" TRS connectors. Since the Main, Booth and Session Outputs have the same Mix, you can run any of them to your main amplifier if the proper cables are not available.

The Main Mix section has a quasi-peak stereo meter with peak hold.



Software Controls

The Sixty-Two Mixer has dedicated Serato DJ software controls for the Left Virtual Deck and Right Virtual Deck. The mixer has two high-speed USB ports, USB A and USB B. Virtual Deck and associated Deck controls are assigned to USB A or USB B using the Deck 1 and 2 **SOURCE** selectors.

When **A** is selected for the **DECK 1 SOURCE**, the **SP-6 ASSIGN** button at the top of the **left-hand** control strip turns **green** to coincide with the silk-screen color for **USB A**. When **B** is selected, the **SP-6 ASSIGN** button turns **orange** to coincide with the color for **USB B**.

When **A** is selected for the **DECK 2 SOURCE**, the **SP-6 ASSIGN** button at the top of the **right-hand** control strip turns **green** to coincide with the silk-screen color for **USB A**. When **B** is selected, the **SP-6 ASSIGN** button turns **orange** to coincide with the color for **USB B**.

The MIDI controls are only sent to the selected port, allowing completely independent Library Browsing, Cue, Loop and Sample control for each USB port. MIDI controls not dedicated to a channel strip, such as SP-6 sample player controls, are assigned to the Left or Right control-strip using the **SP-6 ASSIGN** control.

Library Browse

BACK button: Switches the focus between the Crate and Library area in Serato DJ. If you have any panels open in Serato DJ, the **BACK** button will also move the focus between this and the Crate and Library areas.



SCROLL / LOAD encoder: Rotate the knob to scroll through the Crate / Library panel currently in focus. When the focus is in the Crate area, pressing the knob displays the contents of the selected Crate and moves the focus into the Library area. When the focus is in the Library area, pressing the knob loads the selected track to the Virtual Deck. Double-pressing will load an instant double to this Deck from the opposite Deck.

Loops Manual / Auto

MANUAL / AUTO button toggles the state of the Loop controls between Manual and Auto Loop mode. In Manual mode, the **LOOP** buttons light **green** to correspond with the **green** lines by the **LOOP** controls. In Auto mode, the buttons are lit **orange** to correspond with the **orange** lines.

Manual Loop Controls

When Manual Loop mode is selected, loop control buttons are illuminated **green**. Loop buttons flash during loop playback.

SELECT - Selects a loop slot in Serato DJ when the encoder is pressed.

IN - Sets a loop in point.

OUT - Sets a loop out point.

LOOP - Turns a loop on or off.

Auto Loop Controls

When Auto loop mode is selected, loop control buttons are illuminated **orange**.

BARS - Selects the auto loop length in Serato DJ. This can be adjusted while an auto loop is already looping as an effect.

LOOP - Performs an auto loop of the number of Bars selected.

ROLL - Performs a loop roll of the number of Bars selected.

SAVE - Saves the current loop to an available loop slot in Serato DJ.

Cues / Samples control

The center **CUES / SAMPLES** button toggles the ten buttons between CUES and SAMPLES modes.

In **CUES** mode, the **CUES / SAMPLES** button is **orange** and the Cue buttons are **green**. There are five Cue buttons dedicated to the Left Virtual Deck and five dedicated to the Right Virtual Deck, numbered above each button.

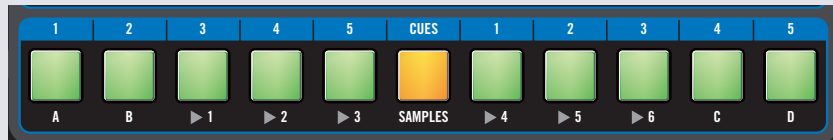

The center **CUES / SAMPLES** button is **red**, the four Bank buttons **A, B, C** and **D** are **orange** and the six Sample buttons are **green**. Sample buttons are assigned to **USB A** or **USB B** using the **SP-6 ASSIGN** button at the top of each control strip.

In **SAMPLES** mode, the **CUES / SAMPLES** button is **red**, the four Bank buttons **A, B, C** and **D** are **orange** and the six Sample buttons are **green**. Sample buttons are assigned to **USB A** or **USB B** using the **SP-6 ASSIGN** button at the top of each control strip.

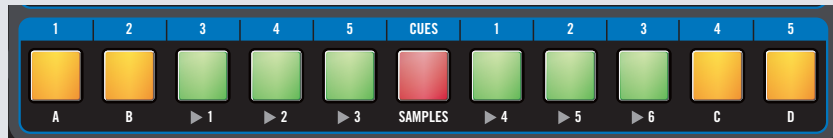

Cue Points

In CUE mode, you can set and trigger five cue points for each Virtual Deck using the Cue buttons. If a Cue is set in Serato DJ, a Cue button is lit bright **green**, and pressing it will trigger the corresponding Cue point in Serato DJ. If a corresponding Cue point is not set, the button will be dim and pressing it will set a new cue point. Hold **SHIFT** and press a Cue button to delete a cue. See Cue Points in the Serato DJ Manual.

Sample Player (SP-6) Triggers

In SAMPLES mode, you can trigger six samples in each of four banks. Select Bank A, B, C or D. An **orange** Bank button is brightly lit if any of the six slots in that bank have a track loaded, and that Bank is currently selected. When a bank is selected, any **green** Sample button with a track loaded in the corresponding slot is brightly lit. The button flashes while its sample is playing. The Play behavior follows the behavior selected in Serato DJ. Sample playback can be assigned to the Left Virtual Deck, Right Virtual Deck or **USB AUX**. The Sixty-Two has a dedicated USB AUX input for the sample player typically used for SP-6 playback. When two USB ports are in use, the **SP-6 ASSIGN** button at the top of each control strip determines to which computer the SP-6 player controls are assigned. Audio from both USB ports is summed in the mixer.



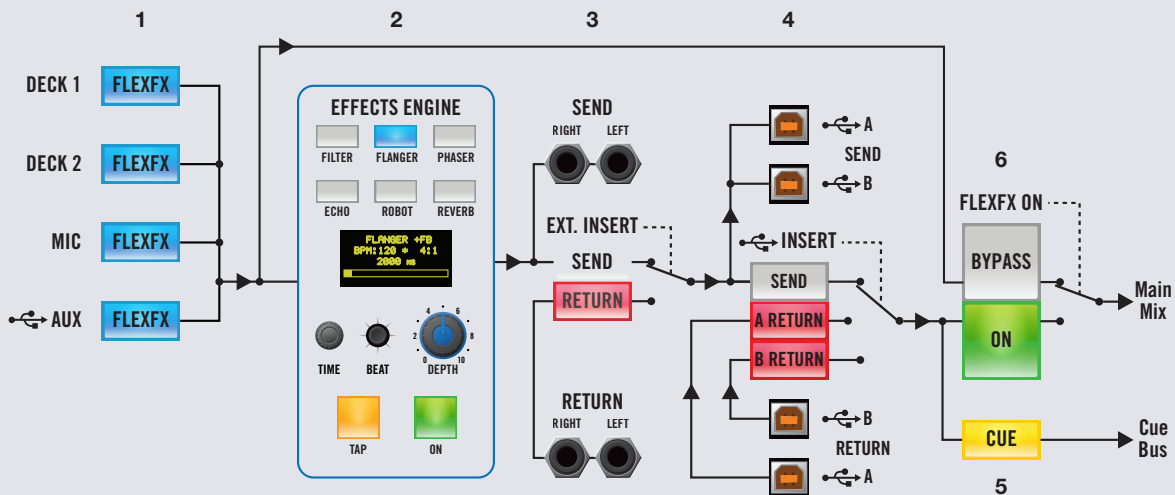

FlexFX Loop

The FlexFX Bus in the Sixty-Two works differently than a typical effects insert loop. This architecture opens up many new possibilities not possible with simple effect insert designs found on other mixers.



The FlexFX Bus is more like an auxiliary bus that can have multiple signals assigned to it. Signals assigned to the bus may then have internal effects, external analog effects and external USB effects applied in any combination. The order of processing in the FlexFX Bus is shown in the graphic below.



- 1.** FLEAFX buttons for DECK 1, DECK 2, MIC and AUX assign signals to the FlexFX Bus (**bright blue**) or the Main Mix (**dim blue**). This allows assigning multiple inputs to the FlexFX Bus and/or changing the assignment without interrupting audio.
- 2.** The six effect buttons both turn on and sync an internal effect. By keeping this separate from the effects **ON** button, it is possible to turn on, sync and cue effects before you hear the wet signal in the Main Mix. Only one internal effect is selected at a time. Having six independent buttons, it is possible to drum in different effects without interruption.
- 3.** EXT. INSERT is turned on/off with a separate button. The external analog insert can be used with internal effects and the INSERT or independently. **NOTE: If no external connection is made to the FLEAFX LOOP RETURN jack, the signal will be interrupted when the EXT. INSERT button is turned on.**

- The  **INSERT** is turned on/off with a separate button, and can be used with internal effects, the **EXT. INSERT** or independently. The  **INSERT** uses USB record pair 9-10 for the Send and USB playback pair 7-8 for the Return. Using the  **INSERT** generally requires a low-latency driver control panel setting. **NOTE: Assign a Deck channel or signal to FLEXFX before engaging the  INSERT button to avoid audible artifacts.**
- The FlexFX **CUE** is after the internal effects insert, analog external insert, USB insert and before the effects **ON** function. This allows cueing a Wet signal while listening to the Dry signal before turning the effect **ON**.
- When effect **ON** is not engaged, internal effects insert, analog external insert and USB insert points are bypassed, and any signal assigned to the FlexFX Loop is simply summed into the Main Mix. This allows you to **CUE** the wet signal before the wet signal is heard in the Main Mix.

Internal Audio Effects

The internal effects engine is in the FlexFX Loop. This allows any combination of **DECK 1**, **DECK 2**, **MIC** and  **AUX** to be assigned to an effect. Individual effects are turned on/off using the six effects buttons. **EXT. INSERT** and  **INSERT** are also engaged independently. The FlexFX Loop (which includes the External Insert and the USB Insert) is turned On/Off with the FlexFX **ON** button (off bypasses the loop).

The six built-in effects are:

- **FILTER**
- **FLANGER**
- **PHASER**
- **HOLD ECHO**
- **ROBOT**
- **REVERB**

General Behavior

- The effect multiplier is saved for each effect.
- Changing BPM for one effect changes the BPM for all effects.
- Tapping the BPM requires at least two taps.
- Changing the **BEAT** multiplier results in an immediate change in the effect time.
- Changing the effect BPM adjusts the multiplier for other effects so that the new multiplier is as close as possible to the saved effect time.

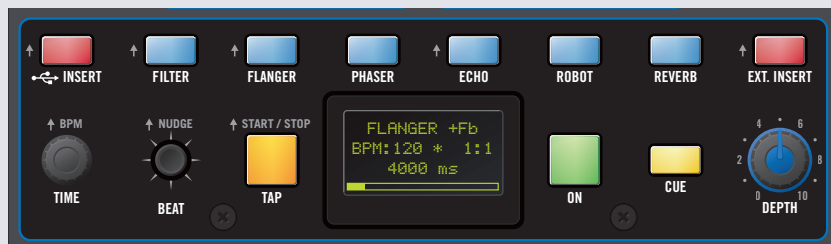

Echo Effects

Echo is an audio effect which records an input signal and then plays it back after a period of time. The delayed signal may be played back multiple times to create the sound of a repeating, decaying echo. The amount of recirculation determines the echo decay rate. There are four available Echo options:

- Echo: No feedback filter and adjustable recirculation 0 to 70%.
- Duck Echo: Adjustable feedback filter and adjustable recirculation 0 to 70% (see Duck Echo below).
- Low-Cut Echo: Adjustable feedback filter and adjustable recirculation 0 to 70%.
- Low-Cut Hold Echo: Adjustable feedback filter and adjustable recirculation of 0% to 100%.

The feedback-filter types help reduce the “muddy” sound that can result when using a lot of recirculation. The type of Echo is selected in the menu on the mixer in the "Echo Effect Options Menu" on page 20, or in the "Driver Control Panel" on page 24. Operation of the Echo controls is detailed in the "Effects Parameter Table" on page 19.

Duck Echo uses a high-pass feedback filter like the Low-Cut Echo. In the presence of signal, the Duck Echo operates 100% dry (no echo is heard). When signal is removed, the delay is enabled and operates according to the **DEPTH** knob setting just like the standard High-pass Echo. This is great for having a song echo out regardless of what terminates play (fader cut, song ends filter cut etc.).

Effects Display, BPM Source and Match Indicator

The effects display shows the name of the current effect, BPM, MIDI Beat-Clock source, Beat Multiplier and Time. A bar graph represents the effect time relative to its range. If no effect is selected, the information for the last effect is displayed. The display for the Robot and Reverb is somewhat different.

There are four possible BPM sources:

- (*) Manual Tap
- (S) Serato DJ
- (A) USB A Beat-Clock,
- (B) USB B Beat-Clock.

To change the BPM source, press and hold the **TAP** button and use the **BEAT** joystick to step through the sources. If a new BPM is manually tapped in or the time is manually altered, the BPM source returns to (*) Manual.

The effect time is normally a product of the BPM and the Beat Multiplier. If the right arrow ► or left arrow ◀ appears, there is an inequality between the BPM*Beat and Time. The arrow indicates which way to adjust the Beat Multiplier to correct the inequality and get the closest possible time. If the BPM source is displayed (*, S, A, B), the BPM*Beat matches the displayed Time.

For example, 120 BPM with a 4:1 Beat Multiplier would result in an effect Time of 2000 ms. If the Time is adjusted to a different value, such as 2097 ms, an arrow indicates that the product of the displayed BPM and Beat Multiplier does not result in the displayed effect Time. For this example, 2000 ms is below 2097 ms. In this case, moving the **BEAT** joystick left or down snaps to 120 * 4:1 and changes the time to 2000 ms.

A flashing Beat Multiplier indicates that the Time required to match the current BPM*Beat product is out of range. For an echo example, if a BPM of 60 is used with a Beat Multiplier of 8, the resulting time is 8000 milliseconds. If the multiplier is set to 16, the resulting time would be 16000 milliseconds, which is out of range. In this case, the time remains at 8000 milliseconds and the multiplier flashes.

Effects Synchronization

This mixer can synchronize its internal effects to four sources as described in the preceding section. The desired clock source is selected by holding down the **TAP** button and pushing the **BEAT** joystick up/right or down/left. The selected source (*, S, A, B) is displayed just following the BPM number. Manually tapping a BPM forces the selection to (*) Manual.

Pressing a **FLEXFX** button with no other **FLEXFX** button engaged, with a BPM-tagged song playing in Serato DJ on that channel, forces the clock source to (S) Serato DJ. The mixer will continue to track the Serato DJ BPM until a new BPM is manually tapped or a new clock source is selected. When one of S, A, or B is selected, the clock source indicator will flash when the mixer is actively following the selected clock.

At any point the BPM and BPM source can be locked. By clicking in on the **BEAT** joystick, the current BPM is frozen and the BPM source is set to (*) Manual and locked. The BPM label on the display flashes to indicate that the BPM source has been locked. The mixer will not change the BPM or BPM source until the user manually enters new BPM or time information, changes the BPM source, or unlocks the BPM by clicking in once more on the joystick.

Regardless of the clock source, the mixer broadcasts the current MIDI Beat-Clock to both USB ports when the Send MIDI Beat Clock option is selected in the MIDI Configuration page of the driver control panel. Both USB ports will also echo out any system real-time messages from the host computer.

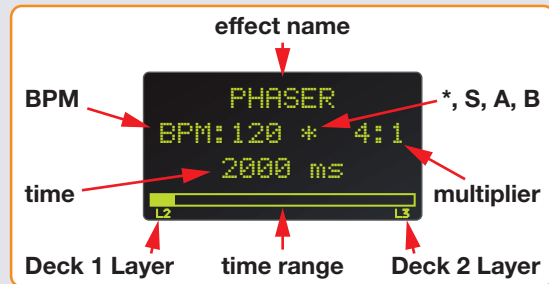

Effects Parameter Table

Effect	Depth Knob	Time Encoder	Tap Button	Beat Joystick	Shift or Control Panel Option*
Filter		TIME adjusts the LFO time independent of the current BPM and Beat Multiplier.	The TAP button manually enters a new BPM.	BEAT adjusts the BPM multiplier to change the number of bars. Up increases the multiplier, and down decreases the multiplier.	High-Pass Filter with low or high frequency sync. Low-Pass Filter with low or high frequency sync.
Flanger	DEPTH adjusts the strength of the effect.	Holding down the TAP button and turning the TIME encoder adjusts the BPM. Pressing the TIME encoder re-syncs the effect.	A minimum of two taps is required to get a new BPM. Manually tapping in a BPM switches the BPM source to (*) Manual.	Available multiplier values are: 1/16, 1/8, 1/4, 1/2, 3/4, 1/1, 2/1 4/1, 8/1, 16/1, 32/1 and 64/1. (No 64/1 in Echo.)	Flanger with positive feedback. Flanger with negative feedback.
Phaser				Press in on the BEAT joystick to Lock the current BPM. This prevents the current BPM from changing until you manually change the BPM, Time, BPM Clock Source, or click the Beat Joystick button again to unlock it. Locked BPM is indicated by "BPM" flashing in the display.	None
Echo	DEPTH adjusts the amount of echo recirculation, which in turn affects how quickly the echo effect decays. The amount of recirculation varies with the echo options selected (see last column). Setting the control to minimum or "0" results in a Dry signal with the minimum recirculation setting. Setting the control to maximum or "10" results in a Wet signal with maximum recirculation.	TIME adjusts the length of the recorded sample used by the echo. Holding down the TAP button and turning the TIME encoder adjusts the BPM. Pressing the ECHO button clears the echo. Time range is 1 ms to 10920 ms. Hold down the ECHO button and turn the TIME encoder to adjust the filtered echo frequency.	Pressing the TAP button and tilting the BEAT joystick up/right or down/left selects the BPM source. The source is shown in the mixer display after the BPM number: (*) Manual Tap (S) Serato DJ (F) USB A Beat-Clock, (E) USB B Beat-Clock.	Hold down the FILTER button and toggle the BEAT joystick to scroll through Filter types. Hold down the FLANGER button and toggle the BEAT joystick to switch between ± feedback. Hold down the ECHO button and toggle the BEAT joystick to scroll through Echo types.	Echo: No feedback filter. Recirculation is adjustable 0-70%. Duck Echo: Feedback filter adjustable from 20 Hz to 10 kHz. Recirculation is adjustable 0-70%. Low-cut Echo: Feedback filter adjustable from 20 Hz to 10 kHz. Recirculation is adjustable 0-70%. Low-cut Hold Echo: Feedback filter adjustable from 20 Hz to 10 kHz. Recirculation is adjustable 0-100%.
When either Hold Echo option is selected, it is possible to suspend an echo. To engage suspend, press the TIME encoder. The ECHO button flashes, indicating that suspend is active. Suspend terminates input to the delay memory while continuing to play delay memory indefinitely. Press the TIME encoder again to terminate suspend. If you want a suspended echo to gradually decay, turn the DEPTH knob CCW. If you want the decay to stop, turn the DEPTH knob back to or above where it was at when suspend was engaged.					
Robot	DEPTH adjusts the wet/dry mix and warble of the robot.	TIME adjusts the % of pitch shift, shown by the bar in the display. Pressing the TIME encoder resets pitch shift to 0%.	TAP does not affect the robot.	Adjusts the pitch up/right or down/left in 20% steps.	None
Reverb	Adjusts reverb intensity.	Adjusts the % of reverb decay time, shown by the bar in the display.	TAP does not affect reverb.	Adjusts the decay time up/right or down/left in 10% steps.	*Effect options are available in the "Shift Options" on page 20 or in the "Driver Control Panel" on page 24.

Shift Options

Several menus are available on the mixer to set preferences. Available menus are indicated with a gray up ↑ arrow. To select a menu, press and hold the **SHIFT** ↑ button and then press the desired menu key. Note: the Shift button may be labeled as the Delete button on older Sixty-Two Mixers.

Ext. Insert Options Menu

This menu sets the sensitivity of the external analog insert to +4 dBu or -10 dBV. Use the +4 dBu setting when a device operating at 4 Vrms or more is connected to the external FlexFX Loop. Use the -10 dBV setting when connecting lower voltage devices with RCA connectors. The overall loop gain remains unchanged for both settings. Push the **BEAT** joystick up/down to select the desired setting then press the joystick in to keep the selection. Press any effect button or the **SHIFT** button to exit the menu.



Filter Effect Options Menu

The Filter menu allows choosing one of four filter types. Move the **BEAT** joystick up/down to select the desired filter type then press the joystick in to keep the selection. The Low-sync Filters sync to BPM at the low point of the sweep, and the High-sync Filters sync to BPM at the high point of the sweep. Press any effect button or the **SHIFT** button to exit the menu.

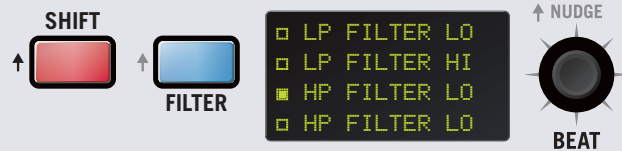

- Low-pass Filter Low-sync.
- Low-pass Filter High-sync.
- High-pass Filter Low-sync.
- High-pass Filter High-sync.

Flanger Effect Options Menu

The Flanger menu allows the choice of positive or negative feedback. Move the **BEAT** joystick up/down to highlight the desired feedback type then press the joystick in to keep the selection. Press any effect button or the **SHIFT** button to exit the menu.



Echo Effect Options Menu

The Echo menu allows selection of four echo effects:

- Echo.
- Echo with high-pass filter.
- Duck Echo.
- Hold Echo with high-pass filter.

Move the **BEAT** joystick up/down to highlight the desired echo type then press the joystick in to keep the selection. For the three high-pass Echo effects, the filter corner frequency is adjusted by highlighting the desired effect and rotating the **TIME** encoder. Press any effect button or the **SHIFT** button to exit the menu.

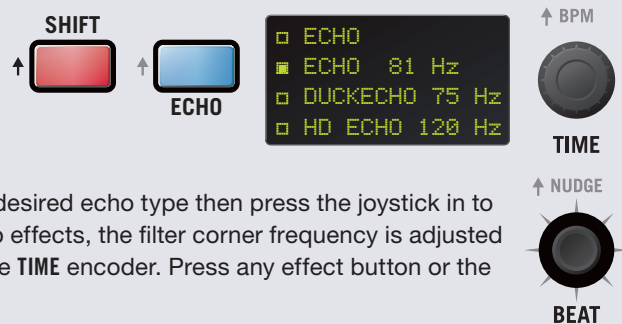

Deck 1-2 Channel Options Menu

A menu is available for each deck input channel. Press and hold the **SHIFT** button then press the **CUE** button of an input channel. This menu allows you to select 1 of 2 USB record sources and set the resonance of the Filter. Record options are:

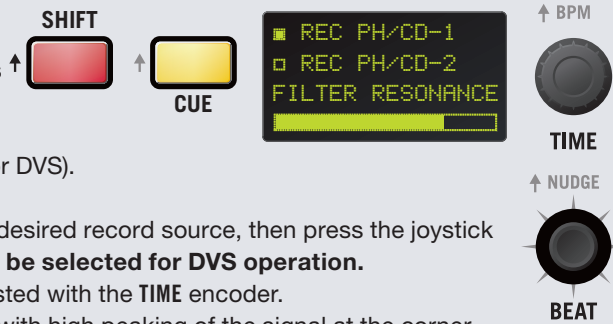

- Pre-selector PH/CD 1 input source (required for DVS).
- Pre-selector PH/CD 2 input source.

Move the Beat joystick up/down to highlight the desired record source, then press the joystick in to keep the selection. **The PH/CD input must be selected for DVS operation.**

Resonance is shown on the bar graph, and adjusted with the **TIME** encoder.

High resonance results in a zippy whistle sound with high peaking of the signal at the corner frequency. High resonance is typically used as an effect. A low resonance settings has no peaking and is typically used for mixing. Press any effect button or the **SHIFT** button to exit the menu.

Mic Option Menu

Press and hold the **SHIFT** button then press the **HOLD** button to view the Mic option menu.



- Record the Main Mix to USB.
- Record only the Mic to USB.
- Clean Feed:

When Clean Feed is selected, the microphone signal is sent directly to the Main Out and is not present in the USB Main Record, Booth Out or Session Out. When set for Clean Feed, the Mic cannot be assigned to FlexFx. If the Mic FlexFx is pressed, the button will blink off to dim.

Mic Bypass Mode

All controls on the mixer are MIDI mappable, including the Mic sections. If you do not use the Mic sections, you can independently bypass the controls so they do not affect



audio, and only output their MIDI changes. This allows you to map the Mic controls to functions in software, such as effects, and not have to worry about introducing noise in your mix from a floating Mic input. To toggle Mic Bypass Mode, hold the **SHIFT** button and press the Mic **ON** button to bypass. The button will start flashing lightly, indicating those audio controls are now bypassed and are only outputting MIDI changes. The Mic On and FlexFX buttons, as well as the Level, Pan, and Tone controls are affected by this mode. While bypassed, the FlexFX and Mic On buttons will flash with momentary button presses, but the LED state cannot be set from software like the side strip controls. Holding the **SHIFT** button and pressing the Mic **ON** button again will exit Mic Bypass Mode, returning the Mic section to regular operation. The Mic **ON** button will return to the “off” state. Be sure to reset the Level, Pan, and Tone controls to appropriate values before switching the Mic back on.

Headphone Tone Control

Press and hold the **SHIFT** button then press the **SPLIT CUE** button to call the headphone menu. Turn the Time encoder up or down to adjust the tone. For larger steps, you can press the joystick left/right. When the bar-graph is in the center, the response is flat. As the control is moved toward Low, low frequencies are boosted and high frequencies are cut. As the bar-graph moves toward High, high frequencies are boosted and low frequencies are cut.

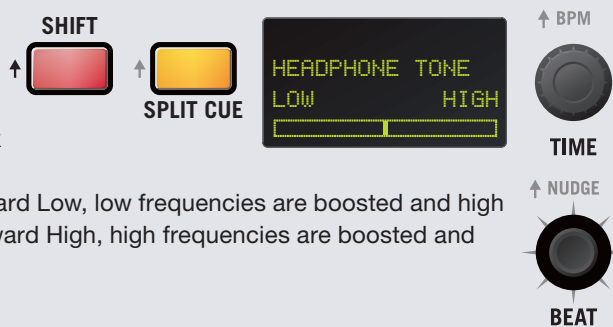

Mixer Shift Functions

In addition to the menu selections, the Shift button also accesses alternate functions for other buttons.

MIDI Start/Stop

Hold the **SHIFT** button and press **TAP** to toggle MIDI Start/Stop messages. MIDI Start is a system real time message instructing devices to start playing a sequence. MIDI Stop tells devices to stop playing the sequence.



Nudge

Hold the **SHIFT** button and use the **BEAT** joystick to “Nudge” the outgoing MIDI beat clock BPM up or down. MIDI beat clock is a system real time message sent 24 times per quarter note.

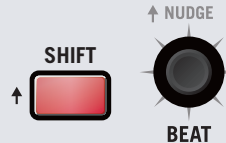

BPM Adjust

Hold the **SHIFT** button and turn the **TIME** encoder to adjust the BPM to a specific value.



Sync

Hold the **SHIFT** button and press **SYNC** to turn Sync on for a Deck. If Sync is already on, pressing Shift/Sync again re-syncs the Deck. Press **SHIFT** and **SYNC OFF** to turn Sync off. See Sync in the Serato DJ manual.

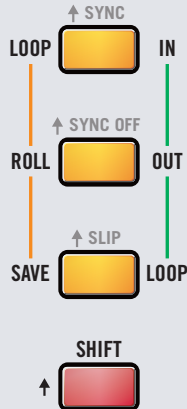



Slip

Hold the **SHIFT** button and press **SLIP** to toggle Slip On or Off. When Slip Mode is active you can manipulate the audio as normal (e.g., Scratch, Loop, Cues etc.). However, once you have finished, playback is returned to where it would be if you had not manipulated the audio. See Slip in the Serato DJ manual.

DJ Changeover

The Sixty-Two allows two computers running Serato DJ to connect to the mixer simultaneously. This allows two DJs to play at the same time and for easy DJ set changeover.

Connect both computers to the two USB ports on the Sixty-Two. For each channel on the mixer, set the **DECK SOURCE** to either  **A** or  **B** depending on which your computer is connected to.

NOTE: If a channel is in use by a computer already, the second computer's Virtual Deck will become black and display IN USE.

When a Deck channel is assigned to a USB port with the **SOURCE** selector, both MIDI and audio are assigned to the **A** or **B** port. MIDI assignment for Deck 1 and Deck 2 mixer controls and the associated side control strip follow the **SOURCE** selection. The color of the **SP-6 ASSIGN** button at the top of each control strip follows the USB port assignment made by the **SOURCE** selector: **green** for USB A and **orange** for USB B. Pressing the **SP-6 ASSIGN** button assigns sample player controls to the indicated port. It also assigns other mixer MIDI. See "**Software Controls**" on page 14.

NOTE: Settings are saved in the mixer. Software is updated with the mixer's settings. Therefore, the mixer may replace control source and effect settings in Serato DJ or software control panels with current mixer settings.

Swapping between two DJs is now easier than ever! With a computer already connected to the Sixty-Two and playing, do the following:

1. Connect the second computer to the unused USB port on the Sixty-Two.
2. Switch the **DECK SOURCE** on the non-playing mixer channel to the USB source of the second computer.
3. Play a track on this Deck and mix it in when ready — you'll now have audio from both computers in the mix.
4. Fade out the audio playing from the first computer to the audio playing from the second computer.
5. When only audio from the second computer is left in the mix, remove the first computer.
6. Assign the **DECK SOURCE** for the remaining free mixer channel to the second computer and keep rocking.

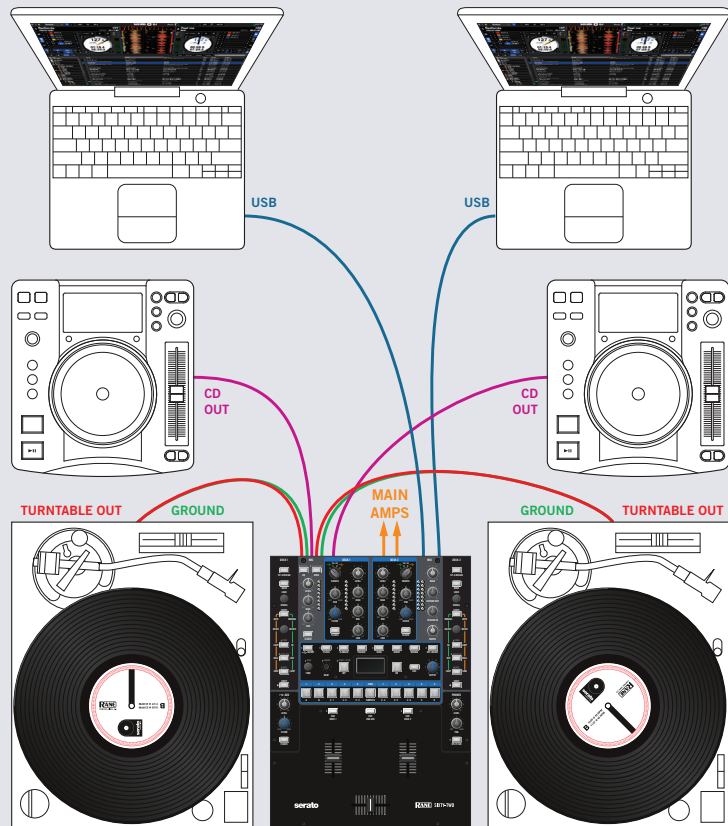

Driver Control Panel

ASIO (Windows)

The Sixty-Two comes with a low-latency ASIO device driver on the installation CD to interface with Serato DJ and other 3rd-party software applications on Windows operating systems. Multi-client ASIO allows different audio software applications to simultaneously stream audio to and from the Sixty-Two. If the same playback channel is selected in more than one application, the driver mixes the audio from the applications before streaming it to the device. The driver Control Panel may be launched from the Windows Control Panel. Select Start > Control Panel > Rane Sixty-Two. It can also be launched from within Serato DJ in the Audio tab of the Setup screen.

Core Audio (Macintosh)

The Sixty-Two uses a low-latency Core Audio device driver on the installation CD to interface with Serato DJ and other 3rd-party software applications on Macintosh operating systems. Core Audio allows audio software applications to simultaneously stream audio to and from the Sixty-Two. To launch the Sixty-Two driver Control Panel, open the System Preferences window. Locate the Sixty-Two in the "Other" section and click the Sixty-Two icon.

NOTE: Settings are saved in the mixer. The control panel for Windows or Macintosh is updated with the mixer's settings. Therefore, when you connect to a different Sixty-Two Mixer, it's saved settings override your previous Control Panel settings.

The control Panel consists of four pages: Preferences, Program Inputs 1-2, Effects and MIDI. The current page title is in the top center. To move between the four pages, click the  icon with the next title in the upper left-hand corner of the control panel.

Preferences page controls

- **USB-6 (11-12) Record source:** Two radio buttons select the Main Mix or Mic.
- **USB-3 (5-6) Filter Resonance:** Slider adjusts the resonance from Low to High for the  AUX Filter.
- **USB Port Status:** Indicates active USB port(s).
- **Buffer Size:** The Buffer Size control allows the USB driver buffer to be increased or decreased. The Sixty-Two drivers are designed to run at latencies as low 8 milliseconds. However, computer performance and available resources (number of applications running) may adversely affect the computer's ability to stream audio reliably. If pops and clicks are heard in the USB audio, try increasing the buffer size to eliminate them. With ASIO, total round-trip latency is equal to Buffer Size plus device latency. With Core Audio, total round-trip latency is equal to Buffer Size plus software application buffer latency, plus device latency. Device latency is 2.26 ms.
- **Update Device Firmware:** This panel indicates the firmware version currently installed in the Sixty-Two. If the Sixty-Two firmware installed on your computer is newer than the firmware in your Sixty-Two, the Update Device Firmware panel is enabled. Pressing the Update Firmware button updates the Sixty-Two firmware to the newer version.

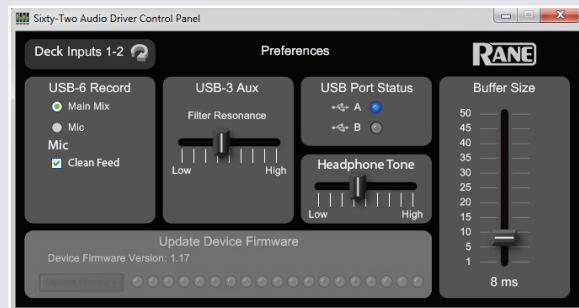

Deck Inputs 1-2 Page Controls

There is one panel for each channel strip on the mixer. Each Deck panel controls these functions:

- Analog Input Source:** The analog input for each channel may be set for Line level (CD) or Phono level (PH) using a switch on the rear of the mixer. PH/CD 1 and PH/CD 2 are associated with Deck 1. PH/CD 3 and PH/CD 4 are associated with Deck 2. The control panel shows the input mode selected on the mixer for each of the four inputs. The mode can only be changed on the mixer.
- Phono Sensitivity:** If Phono Input is selected on the mixer, the Phono Sensitivity adjustment appears in the panel. Click the down-arrow to display a list of 16 sensitivity settings between 2.5 mV and 10 mV in 0.5 mV steps. The default is 5 mV. Set the Phono Sensitivity to the same level of your cartridge (see your cartridge documentation for the correct value). Another method is to match the level of a CD on another input.
- Filter Resonance:** Each channel of the Sixty-Two has a Filter knob that provides High- and Low-Pass filtering. Filter resonance controls the “peak” of the filter cutoff frequency. The Low setting provides the smoothest Filter without adding gain. The High setting adds accent to frequencies near the Filter cutoff point by adding about 12 dB of gain. Adding gain in a narrow region around the cutoff frequency adds a “zip” effect to audio as the Filter is swept. The default is 5 dB.
- USB-3 (5-6) Record Source:** This control allows users to select one of two analog sources as the vinyl emulation or USB record source for Deck 1. The two radio buttons allow the user to select PH/CD 1 or PH/CD 2. The post Deck 1 fader signal is always available for recording on USB 1 (1-2) record.
- USB-4 (7-8) Record Source:** This control allows selecting one of two analog sources as the vinyl emulation or the USB record source for Deck 2. The two radio buttons allow the user to select PH/CD 3 or PH/CD 4. The post Deck 2 fader signal is always available for recording on USB 2 (3-4) record.

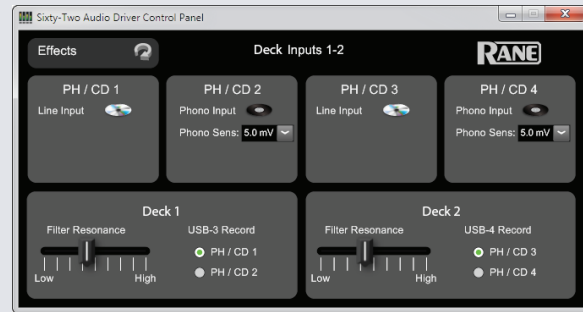

Effects Page Controls

The Filter panel has four radio buttons allowing users to select filter type and sync mode:

- High-Pass Filter with high-frequency sync.
- High-Pass Filter with low-frequency sync.
- Low-Pass Filter with high-frequency sync.
- Low-Pass Filter with low-frequency sync.

The Flanger panel has two radio buttons allowing users to select one of two feedback modes:

- Positive feedback.
- Negative feedback.

The Echo panel allows users to select one of four echo modes:

- Echo with no feedback filter and adjustable recirculation 0 to 70%.
- Duck Echo: Feedback filter adjustable from 20 Hz to 10 kHz. Recirculation is adjustable 0-70%.
- Low-Cut Echo with adjustable feedback filter and adjustable recirculation 0 to 70%.
- Low-Cut Hold Echo with adjustable feedback filter and adjustable recirculation of 0% to 100%.
 - The sliders in the control panel set the low-cut filter cut off frequency.

Default Effects settings are:

- Low-Pass Filter with high-frequency sync.
- Flanger with positive feedback.
- Echo with no feedback filter.
- Echo filter frequencies default to 82 Hz.

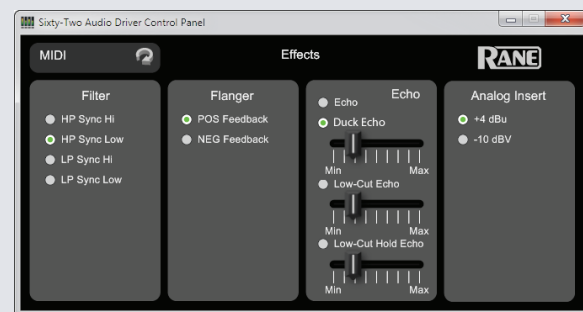

The **Analog Insert** panel has two options:

- +4 dBu
- -10 dBV

We recommend the +4 dBu setting unless you insert a low-voltage device, in which you should use the -10 dBV setting.

MIDI Configuration Page:

- When **Receive MIDI Beat Clock** is checked, the mixer receives MIDI Real Time System Messages.
- When **Send MIDI Beat Clock** is checked, the mixer sends MIDI Real Time System Messages.
- When **User Button Lighting** is checked, the mixer will not automatically light button LEDs for momentary presses. Enable this option if you wish to send MIDI commands to the mixer from third-party software to control button LEDs.

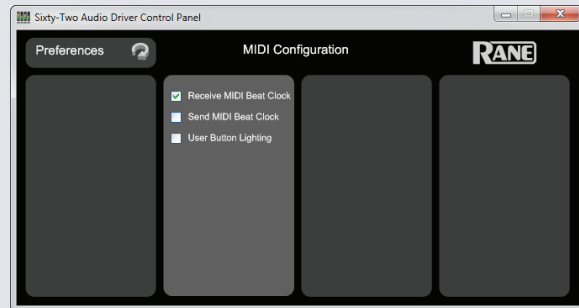

Factory Defaults

To reset the Sixty-Two Mixer's:

- Record/Control Sources
- LP/HP Filter Resonances
- Filter Type, Flanger and Echo effects

to factory default settings:

1. Power off the Sixty-Two.
2. Push both Deck 1 and 2 FLEAFX buttons at the same time.
4. While holding these buttons down, power on the Sixty-Two.
5. Immediately after fading up, the FLEAFX lights flash one time, indicating a successful reset.

NOTE: Settings are saved in the mixer. Software is updated with the mixer's settings. Therefore, the mixer may replace control source and effect settings in Serato DJ or software control panels with current mixer settings that may have been changed by a different laptop.

MIDI Mapping

When using Serato DJ or Scratch Live software, the mixer is plug-and-play with all required MIDI mapping done for you. For advanced users or with third-party DAWs, it is possible to custom MIDI-map most mixer controls on the Sixty-Two and control the lighting and color of buttons in the Serato DJ control strips.

There are three groups of MIDI controls:

- Those associated with Deck 1 and the left-hand control strip.
- Those associated with Deck 2 and the right-hand control strip.
- Mixer controls not associated with Deck 1, Deck 2 or either control strip.

There are two USB ports on the mixer, **USB A** and **USB B**. Users can assign each of these three groups to **USB A** or **USB B** as follows:

- The **SOURCE** selector for Deck 1 determines which USB port will be used for Deck 1 controls and the associated left-hand control strip.
- The **SOURCE** selector for Deck 2 determines which USB port will be used for Deck 2 controls and the associated right-hand control strip.

To assign MIDI controls not related to Deck 1 or Deck 2, press the **SP-6 ASSIGN** button at the top of a control strip and it will light brightly to indicate that controls belonging to the third MIDI group are assigned to the same USB port. The one exception is the crossfader, which is always sent to both USB ports.

MIDI Assignments

As indicated in the Top Panel MIDI Assignments graphic, there are unique MIDI assignments for Loop controls when in AUTO and MANUAL modes. There are also unique MIDI assignments for Cue and Sample buttons when in CUE and SAMPLES modes.

MIDI Layers

The mixer is capable of changing MIDI Layers in order to MIDI map one control to multiple functions under different contexts. Changing the MIDI Layer is the same thing as changing the MIDI channel. The MIDI Layers used for Left Deck and Right Deck can be independently selected. The third group of controls that is not associated with Deck 1, Deck 2 or either control strip will use the MIDI Layer of the group that it is assigned to with the **SP-6 ASSIGN** button. By default, the other MIDI Layers inherit the functionality of the first Layer. The crossfader is the only control that will only send traffic on MIDI Layer 1.

- Holding down the **CUES / SAMPLES** button will turn all of the Cue buttons yellow. The Left Deck Cue buttons and Right Deck Cue buttons will each have one Cue button brightly lit. The button that is brightly lit indicates the current MIDI Layer for that group.
- While holding down the **CUES / SAMPLES** button, press the Cue button corresponding with the desired MIDI Layer. This will change the MIDI Layer for the deck that Cue button belongs to. It is not necessary to wait for the Cue buttons to display the current MIDI Layer in order to change the MIDI Layer.
- MIDI layer corresponds to the MIDI channel:

MIDI Layer	MIDI Channel
1	1
2	3
3	4
4	5
5	6

MIDI layers other than default Layer 1 are shown at the bottom of the effects display, Deck 1 on the bottom left and Deck 2 on the bottom right. If Layer 1 is selected, it is not displayed. This allows a user to see at a glance if any of the Decks are in a layer other than Layer 1.

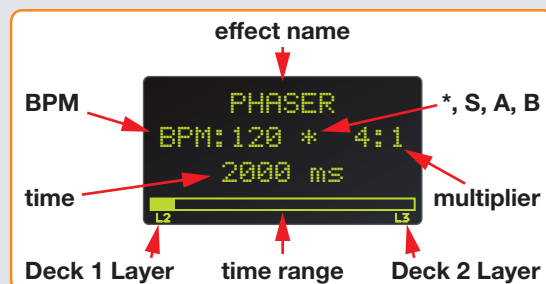

NOTE: The Serato DJ controls on the mixer's control strips are not mappable in Layer 1 because they are reserved for the default Serato DJ functions. These controls are fully mappable in Serato DJ on all other MIDI Layers. All controls on all layers are mappable in third-party applications that support MIDI Mapping.

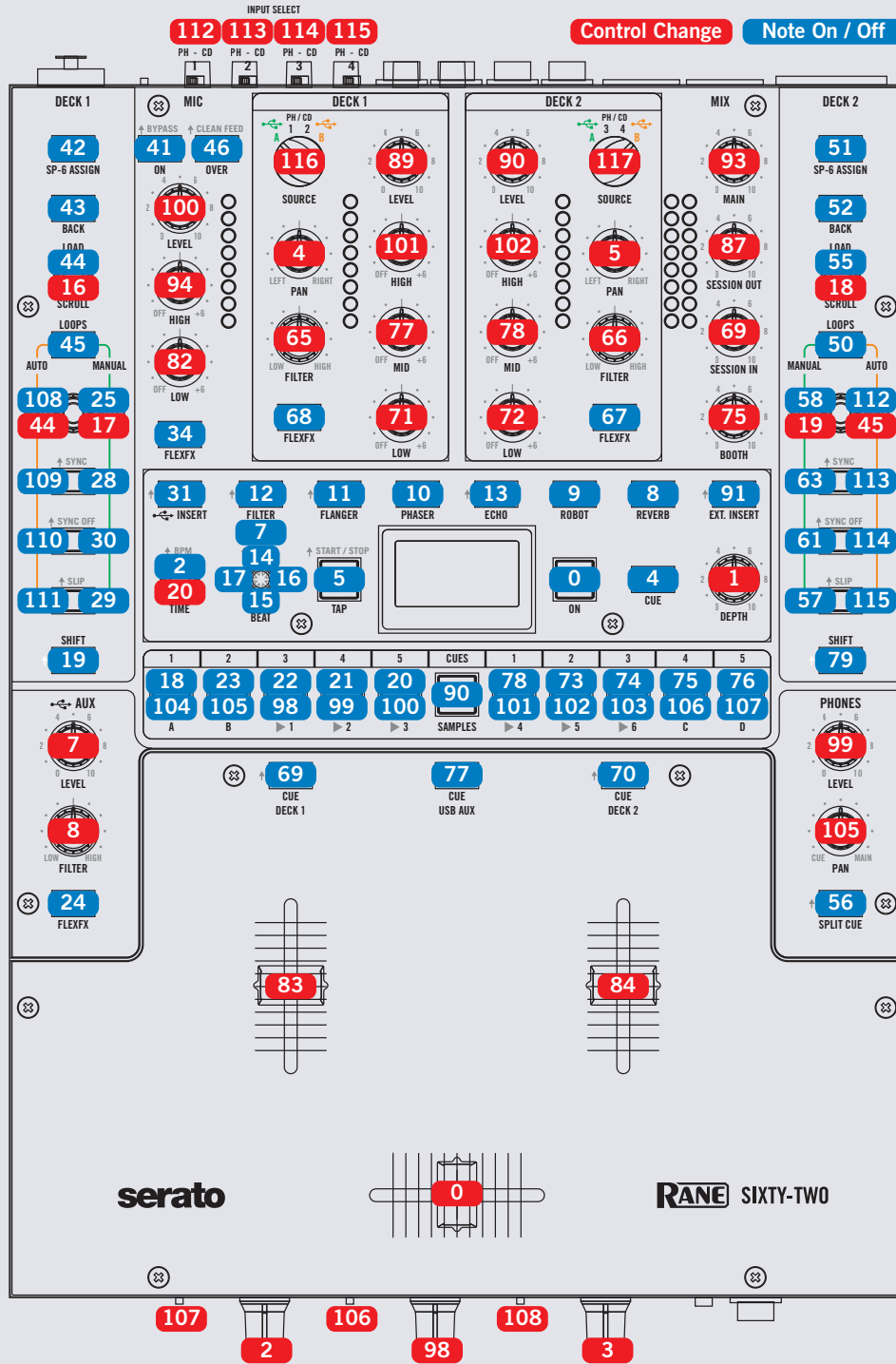

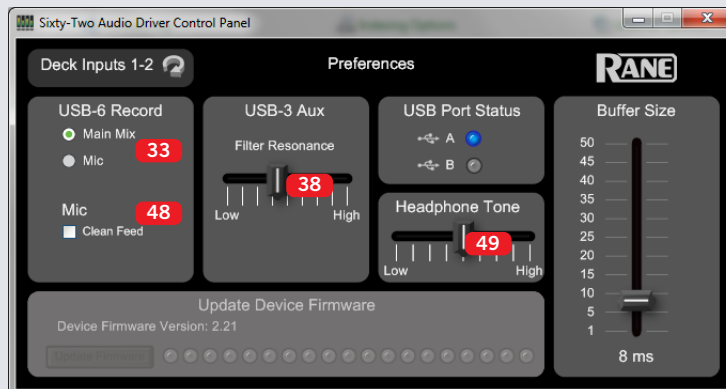
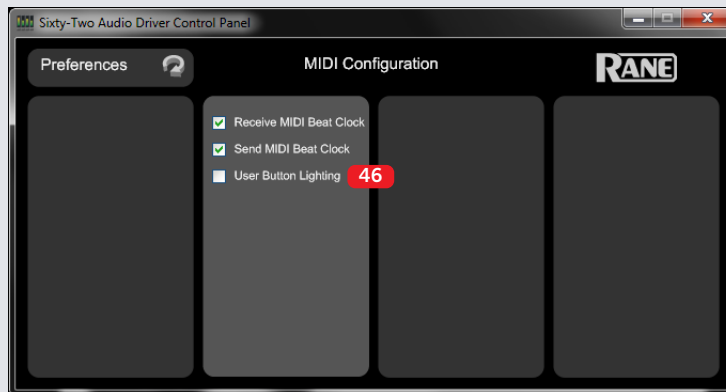
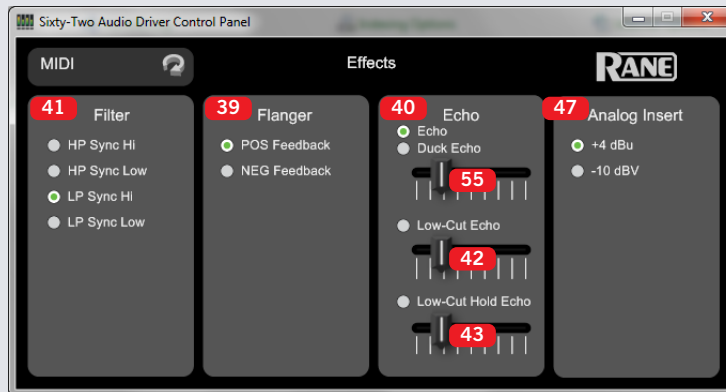
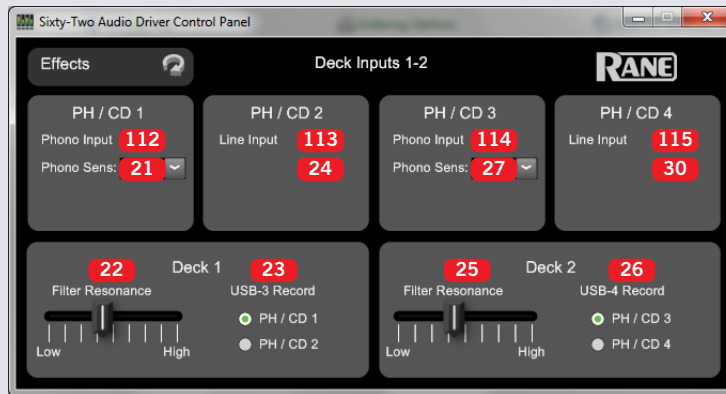

MIDI Implementation

Serato DJ MIDI Control only supports:

- Note On/Off
- Standard 7-bit CC (Control Change)

MIDI Note ON/OFF Chart

The note number for an LED indicator under a button is the same as for the button.

The color and brightness of an LED is determined by the velocity as follows:

- 0-30 0x00-0x1E Off
- 31-47 0x1F-0x2F Primary Dim
- 48-78 0x30-0x4E Primary Full
- 79-95 0x4F-0x5F Secondary Dim
- 96-127 0x60-0x7F Secondary Full

There are two categories of note on/off MIDI controls:

Red: Dedicated mixer controls are read only and not affected by MIDI in commands. A user is not able to control mixer functions via MIDI and is unable to change the color or intensity of an LED under one of these mixer controls. Users are able to use MIDI out for these controls to trigger or control software functions.

Green: MIDI controls on the mixer dedicated to Serato DJ or 3rd-party DAW control. These controls are read/write and a user is able to control the color and intensity of LEDs under these buttons.

Note #	Hex #	Function	LED States		Type
0	0x00	FlexFX On	Not Permitted		Mixer Control
2	0x02	FX Time Encoder Push	Not Applicable		Mixer Control
4	0x04	FlexFX Cue	Not Permitted		Mixer Control
5	0x05	FX Tap	Not Permitted		Mixer Control
7	0x07	Beat Joystick Push	Not Applicable		Mixer Control
8	0x08	Reverb	Not Permitted		Mixer Control
9	0x09	Robot	Not Permitted		Mixer Control
10	0x0A	Phaser	Not Permitted		Mixer Control
11	0x0B	Flanger	Not Permitted		Mixer Control
12	0x0C	Filter	Not Permitted		Mixer Control
13	0x0D	Echo	Not Permitted		Mixer Control
14	0x0E	Beat Joystick North	Not Applicable		Mixer Control
15	0x0F	Beat Joystick South	Not Applicable		Mixer Control
16	0x10	Beat Joystick East	Not Applicable		Mixer Control
17	0x10	Beat Joystick West	Not Applicable		Mixer Control
18	0x12	LH Cue-1	PRI – Green	SEC – Yellow	DAW MIDI Control
19	0x13	LH Delete	PRI – Red	SEC - Orange	DAW MIDI Control
20	0x14	LH Cue-5	PRI – Green	SEC – Yellow	DAW MIDI Control
21	0x15	LH Cue-4	PRI – Green	SEC – Yellow	DAW MIDI Control
22	0x16	LH Cue-3	PRI – Green	SEC – Yellow	DAW MIDI Control
23	0x17	LH Cue-2	PRI – Green	SEC – Yellow	DAW MIDI Control
24	0x18	USB AUX FlexFX	Not Permitted		Mixer Control
25	0x19	LH Manual Loop Select Encoder Push	Not Applicable		DAW MIDI Control
28	0x1C	LH Manual Loop In	PRI – Green	SEC – Orange	DAW MIDI Control
29	0x1D	LH Manual Loop	PRI – Green	SEC – Orange	DAW MIDI Control
30	0x1E	LH Manual Out	PRI – Green	SEC – Orange	DAW MIDI Control

31	0x1F	USB Insert	Not Permitted		Mixer Control
34	0x22	Mic FlexFX	Not Permitted		Mixer Control
41	0x29	Mic ON	Not Permitted		Mixer Control
42	0x2A	LH SP-6 Assign	Not Permitted		Mixer Control
43	0x2B	LH Back	PRI – Green	SEC – Orange	DAW MIDI Control
44	0x2C	LH Scroll Encoder Push	Not Applicable		DAW MIDI Control
45	0x2D	LH Manual/Auto Loop	Not Permitted		Mixer Control
46	0x2E	Mic Talk-over	Not Permitted		Mixer Control
50	0x32	SR Manual/Auto Loop	Not Permitted		Mixer Control
51	0x33	SR SP-6 Assign	Not Permitted		Mixer Control
52	0x34	RH Back	PRI – Green	SEC – Orange	DAW MIDI Control
55	0x37	RH Scroll Encoder Push	Not Applicable		DAW MIDI Control
56	0x38	Split Cue	Not Permitted		Mixer Control
57	0x39	RH Manual Loop	PRI – Green	SEC – Orange	DAW MIDI Control
58	0x3A	RH Manual Loop Select Encoder Push	Not Applicable		DAW MIDI Control
61	0x3D	RH Manual Out	PRI – Green	SEC – Orange	DAW MIDI Control
63	0x3F	RH Manual In	PRI – Green	SEC – Orange	DAW MIDI Control
67	0x43	Deck 2 FlexFX	Not Permitted		Mixer Control
68	0x44	Deck 1 FlexFX	Not Permitted		Mixer Control
69	0x45	Deck 1 Cue	Not Permitted		Mixer Control
70	0x46	Deck 2 Cue	Not Permitted		Mixer Control
73	0x49	RH Cue-2	PRI – Green	SEC – Yellow	DAW MIDI Control
74	0x4A	RH Cue-3	PRI – Green	SEC – Yellow	DAW MIDI Control
75	0x4B	RH Cue-4	PRI – Green	SEC – Yellow	DAW MIDI Control
76	0x4C	RH Cue-5	PRI – Green	SEC – Yellow	DAW MIDI Control
77	0x4D	USB Aux Cue	Not Permitted		Mixer Control
78	0x4E	RH Cue-1	PRI – Green	SEC – Yellow	DAW MIDI Control
79	0x4F	RH Delete	PRI – Red	SEC - Orange	DAW MIDI Control
90	0x5A	Cues/Samples	Not Permitted		Mixer Control
91	0x5B	Ext Insert	Not Permitted		Mixer Control
98	0x62	Sample-1	PRI – Green	SEC – Yellow	DAW MIDI Control
99	0x63	Sample-2	PRI – Green	SEC – Yellow	DAW MIDI Control
100	0x64	Sample-3	PRI – Green	SEC – Yellow	DAW MIDI Control
101	0x65	Sample-4	PRI – Green	SEC – Yellow	DAW MIDI Control
102	0x66	Sample-5	PRI – Green	SEC – Yellow	DAW MIDI Control
103	0x67	Sample-6	PRI – Green	SEC – Yellow	DAW MIDI Control
104	0x68	Bank A	PRI – Green	SEC – Yellow	DAW MIDI Control
105	0x69	Bank B	PRI – Green	SEC – Yellow	DAW MIDI Control
106	0x6A	Bank C	PRI – Green	SEC – Yellow	DAW MIDI Control
107	0x6B	Bank D	PRI – Green	SEC – Yellow	DAW MIDI Control
108	0x6C	LH Auto Loop Select Encoder Push	Not Applicable		DAW MIDI Control
109	0x6D	LH Auto Loop	PRI – Green	SEC – Orange	DAW MIDI Control
110	0x6E	LH Auto Roll	PRI – Green	SEC – Orange	DAW MIDI Control
111	0x6F	LH Auto Save	PRI – Green	SEC – Orange	DAW MIDI Control
112	0x70	RH Auto Loop Select Encoder Push	Not Applicable		DAW MIDI Control
113	0x71	RH Auto Loop	PRI – Green	SEC – Orange	DAW MIDI Control
114	0x72	RH Auto Roll	PRI – Green	SEC – Orange	DAW MIDI Control
115	0x73	RH Auto Save	PRI – Green	SEC – Orange	DAW MIDI Control

MIDI Control Change Chart

Functions highlighted in **red** are MIDI-Out Mixer controls.

Functions highlighted in **blue** are MIDI-In mixer controls.

Functions highlighted in **green** are MIDI-Out Serato DJ or 3rd-party DAW controls.

Control #	Hex #	Function	Values			
0	0x00	Crossfader	0-127,	0x00-0x7F		
1	0x01	FX Depth	0-127,	0x00-0x7F		
2	0x02	Deck 1 Contour	0-127,	0x00-0x7F		
3	0x03	Deck 2 Contour	0-127,	0x00-0x7F		
4	0x04	Deck 1 Left-Right Pan	0-127,	0x00-0x7F		
5	0x05	Deck 2 Left-Right Pan	0-127,	0x00-0x7F		
7	0x07	USB Aux Level	0-127,	0x00-0x7F		
8	0x08	USB Aux Filter	0-127,	0x00-0x7F		
16	0x10	LH Scroll Encoder	2's Complement from 64 / Relative (Binary Offset)			
17	0x11	LH Manual Loop Select Encoder	2's Complement from 64 / Relative (Binary Offset)			
18	0x12	RH Scroll Encoder	2's Complement from 64 / Relative (Binary Offset)			
19	0x13	RH Manual Loop Select Encoder	2's Complement from 64 / Relative (Binary Offset)			
20	0x14	FX Time Encoder	2's Complement from 64 / Relative (Binary Offset)			
21	0x15	Analog 1 Phono Sensitivity	Value	Hex	Sensitivity (mV)	dB
			0	0x00	2.5	16.04
			1	0x01	3	14.46
			2	0x02	3.5	12.12
			3	0x03	4	11.96
			4	0x04	4.5	10.94
			5	0x05	5 (Default)	10.02
			6	0x06	5.5	9.19
			7	0x07	6	8.44
			8	0x08	6.5	7.74
			9	0x09	7	7.10
			10	0x0A	7.5	6.5
			11	0x0B	8	5.94
			12	0x0C	8.5	5.41
			13	0x0D	9	4.92
			14	0x0E	9.5	4.45
15	0x0F	10	4.00			
22	0x16	Deck 1 Filter Resonance	0-127,	0x00-0x7F	Low to High Resonance	
23	0x17	Deck 1 Input Record Source (USB 5-6)	1	0x01	Record A1	
			2	0x02	Record A2	
24	0x18	Analog 2 Phono Sensitivity	Same as Analog 1 Phono Sensitivity			
25	0x19	Deck 2 Filter Resonance	0-127,	0x00-0x7F	Low to High Resonance	
26	0x1A	Deck 2 Input Record Source (USB 7-8)	1	0x01	Record A3	
			2	0x02	Record A4	
27	0x1B	Analog 3 Phono Sensitivity	Same as Analog 1 Phono Sensitivity			
30	0x1E	Analog 4 Phono Sensitivity	Same as Analog 1 Phono Sensitivity			
33	0x21	Main Record Select, (USB 11-12)	1	0x01	Record Main Mix	
			2	0x02	Record Mic	
38	0x26	USB Aux Filter Resonance	0-127,	0x00-0x7F	Low to High Resonance	
39	0x27	FX Flanger Type	0-63,	0x00-0x3F	Negative	
			64-127	0x40-0x7F	Positive	

OWNER'S MANUAL

40	0x28	FX Echo Type	0-31 32-63 64-95 96-127	0x00-0x1F 0x20-0x3F 0x40-0x5F 0x60-0x7F	Echo High-Pass Echo Duck Echo HP Hold Echo
41	0x29	FX Filter Type	0-31, 32-63, 64-95, 96-127	0x00-0x1F 0x20-0x3F 0x40-0x5F 0x60-0x7F	Low-Pass Sync Low Low-Pass Sync High High-Pass Sync Low High-Pass Sync High
42	0x2A	Echo HP Frequency	0-127	0x00-0x7F	20 Hz-10 kHz, Uniform Octave Steps
43	0x2B	Hold Echo HP Frequency	0-127	0x00-0x7F	20 Hz-10 kHz, Uniform Octave Steps
44	0x2C	LH Auto Loop Bars Encoder	2's Complement from 64 / Relative (Binary Offset)		
45	0x2D	RH Auto Loop Bars Encoder	2's Complement from 64 / Relative (Binary Offset)		
48	0x30	Clean Feed	0-63, 64-127	0x00-0x3F 0x40-0x7F	Off On
49	0x31	Headphone Tone	0-127	0x00-0x7F	20 Hz-10 kHz, Uniform Octave Steps
55	0x37	Duck Echo HP Frequency	0-127	0x00-0x7F	20 Hz-10 kHz, Uniform Octave Steps
65	0x41	Deck 1 LP/HP Filter	0-127	0x00-0x7F	
66	0x42	Deck 2 LP/HP Filter	0-127	0x00-0x7F	
69	0x45	Session In Level	0-127	0x00-0x7F	
71	0x47	Deck 1 Low	0-127	0x00-0x7F	
72	0x48	Deck 2 Low	0-127	0x00-0x7F	
75	0x4B	Booth Level	0-127	0x00-0x7F	
77	0x4D	Deck 1 Mid	0-127	0x00-0x7F	
78	0x4E	Deck 2 Mid	0-127	0x00-0x7F	
82	0x52	Mic Low	0-127	0x00-0x7F	
83	0x53	Deck 1 Fader	0-127	0x00-0x7F	
84	0x54	Deck 2 Fader	0-127	0x00-0x7F	
87	0x57	Session Out Level	0-127	0x00-0x7F	
89	0x59	Deck 1 Level	0-127	0x00-0x7F	
90	0x5A	Deck 2 Level	0-127	0x00-0x7F	
93	0x5D	Main Level	0-127	0x00-0x7F	
94	0x5E	Mic High	0-127	0x00-0x7F	
98	0x62	Crossfader Contour	0-127	0x00-0x7F	
99	0x63	Phones Level	0-127	0x00-0x7F	
100	0x64	Mic Level	0-127	0x00-0x7F	
101	0x65	Deck 1 High	0-127	0x00-0x7F	
102	0x66	Deck 2 High	0-127	0x00-0x7F	
105	0x69	Headphone Cue / Main Pan	0-127	0x00-0x7F	
106	0x6A	Crossfader Reverse	0 – Normal, 1 – Reversed		0x00 – Normal, 0x01 – Reversed
107	0x6B	Deck 1 Reverse	0 – Normal, 1 – Reversed		0x00 – Normal, 0x01 – Reversed
108	0x6C	Deck 2 Reverse	0 – Normal, 1 – Reversed		0x00 – Normal, 0x01 – Reversed
112	0x70	PH/CD 1 Select	0 – Phono, 1 – Line		0x00 – Phono, 0x01 – Line
113	0x71	PH/CD 2 Select	0 – Phono, 1 – Line		0x00 – Phono, 0x01 – Line
114	0x72	PH/CD 3 Select	0 – Phono, 1 – Line		0x00 – Phono, 0x01 – Line
115	0x73	PH/CD 4 Select	0 – Phono, 1 – Line		0x00 – Phono, 0x01 – Line
116	0x74	Deck 1 Source Select	1 2 3 4	0x01 0x02 0x03 0x04	USB A Left Virtual Deck, Analog 1 Analog 2 USB B Left Virtual Deck
117	0x75	Deck 2 Source Select	1 2 3 4	0x01 0x02 0x03 0x04	USB A Right Virtual Deck Analog 3, Analog 4 USB B Right Virtual Deck

Magnetic Fader Maintenance

The faders and crossfader in the Sixty-Two are designed with materials highly resistant to corrosion and most chemicals. While they will handle millions of operations, they may become dirty over time. Bad things may be spilled into a fader, but in many instances the fader may not be damaged and the sound quality thus unaffected. Cleaning is only required to maintain the feel of the fader.

In order to maintain the feel of your faders, they may occasionally require cleaning and lubrication. The bearings in the fader work best with DuPont Teflon Multi-use Lubricant (part # D00040101). Make sure to follow the instructions and warnings on the bottle.

This lubricant goes on wet to deeply penetrate moving parts, but sets up with a clean, dry, long-lasting film which will not attract and absorb dirt and grime. Wet or oily lubricants may feel good at first, but will attract dirt and evaporate or become dry over time. See the fader cleaning instructions below.

Fader Assembly Removal

1. Remove all three fader knobs.
2. Remove all six screws holding the fader panel face plate.
3. Lift up the fader panel face plate and set it aside where it can't get damaged.
4. Remove the two screws at each end of a fader, holding the bottom of the fader in place with your other hand.
5. Take out the fader assembly completely.
6. Note the left connector goes to the left fader, the center connector goes to the crossfader, and the right connector goes to the right fader.
7. Unplug the connectors of the white wires at the fader assembly without pulling the wires.

Reverse this procedure to re-assemble.

- Plug in the connector before re-installing the fader. Notice the connector only will fit one way.
- Test all the faders before installing the fader panel face plate and fader knobs.

Fader Cleaning

1. For a light cleaning, move the carrier to one side and wipe rails with a lint-free cloth. Move the carrier to the other side and repeat.
2. If a heavier cleaning is required to remove oily lubricants or grease, first take the carrier off of the rails by removing one of the endblocks. Clean the rails using a lint-free cloth and alcohol. Use a cue-tip and alcohol to clean the carrier bearings.
3. With the fader clean, dry and assembled, add a couple of drops of Teflon Multi-use Lubricant to each rail of the fader.
4. Move the carrier back and forth to distribute lubricant.
5. Do not disturb the position of the small sensors at each end of the fader. If you accidentally do, make sure the parts are standing straight before re-installing.

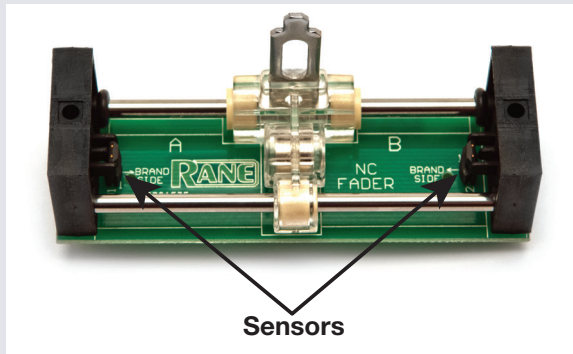

Fader Calibration

After cleaning or replacement, the sensors may get moved, affecting the contour. After any fader service, perform this procedure to re-calibrate the faders and crossfader.

1. Power off the Sixty-Two.
2. Move all faders to the center-most position.
3. Push down both **DECK 1 CUE** and **DECK 2 CUE** buttons at the same time.
4. While holding these buttons down, power on the Sixty-Two.
5. Immediately after fading up, the **CUE** lights will flash one time, indicating a successful calibration. If the **CUE** lights flash three times, the sensors may have moved too far or all faders were not properly centered, and the faders cannot correctly calibrate.

Problems? Contact Rane Corporation customer service at 425-355-6000 or email us at info@rane.com. Online help is available at dj.rane.com.

Technical Specifications

Sixty-Two Specifications	All specifications typical unless otherwise stated
Analog Inputs	4 Stereo unbalanced RCA jacks
.....Phono or Line level input	Rear panel switches for each input
.....Phono Response	RIAA ± 1 dB, Gain: 31 dB at 1 kHz
.....Max Phono Input	126 mV
.....Max Line Input	4 Vrms
ADCs	24-bit 48 kHz; dynamic range 101 dB A-weighted
DACs	24-bit 48 kHz; dynamic range 107 dB A-weighted
Digital Signal Processing	48 kHz, 32-bit floating point
USB Audio	Six Stereo Record, Four Stereo Playback
.....Operation	48 kHz, 32-bit floating point
FlexFX Return	Stereo unbalanced 1/4" TS (tip-sleeve) phone jacks
FlexFX Send	Stereo unbalanced 1/4" TS (tip-sleeve) phone jacks
Mic Input	Balanced 1/4" TRS & XLR combination jack
.....Tone Controls	2-band, High and Low
.....Mic-Line level switch	Choose Line to connect wireless receiver
Line Outputs: Frequency Response	20 Hz to 20 kHz ± 0.25 dB, Line in to Line out
.....THD+N	<0.01% re 0 dBFS, 20 to 20 kHz, 20 kHz BW
.....Unbalanced jacks (RCA & FlexFX)	Maximum 4 Vrms
.....Balanced jacks (Main & Booth)	Maximum 8 Vrms
Universal Power Supply	100 to 240 VAC, 50 Hz to 60 Hz, 15 W max
USB Power	Mixer is self-powered
Unit: Conformity	CE, FCC, cCSAus
.....Size	14.25" x 10.5" x 4" (36.2 x 26.7 x 10.2 cm)
.....Weight	10 lb (4.3 kg)
Shipping Size	7.75" H x 15" W x 19.25" D (19.7 x 38.1 x 49 cm)
.....Weight	14 lb (6.4 kg)

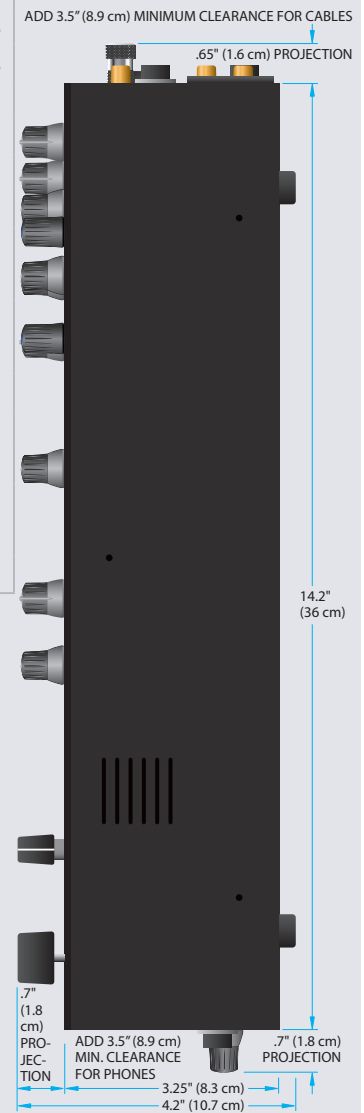

Battle Bridge Accessory

When installing a Sixty-Two mixer in a coffin case, it is important to leave 10 centimeters (3.9 inches) in front and in back of the mixer to allow room for cables and access to controls. The rubber feet provided on the chassis for table top use should remain in place when installing the mixer in a coffin case. When in operation, the coffin case must provide 1 centimeter (0.39 inches) clearance on each side of the mixer and above the controls on the face of the mixer.

A battle bridge kit is available for the Sixty-Two Mixer (also fits the Sixty-Four and -Eight). The brackets install easily with three screws on each side. These are powder-coated electro-galvanized .075" steel.

14" EARS bring the total width of the mixer to 30.5 cm (12") for coffin mounting. These measure 35.8 x 1.9 x 7.7 cm (14" x .75" x 3"). Shipping weight is 1.36 kg (3 pounds).

If you live in the U.S.A, you may buy these ears in the Rane Factory Store at dj.rane.com. Outside the U.S.A., contact your international representative — contacts are at dj.rane.com.

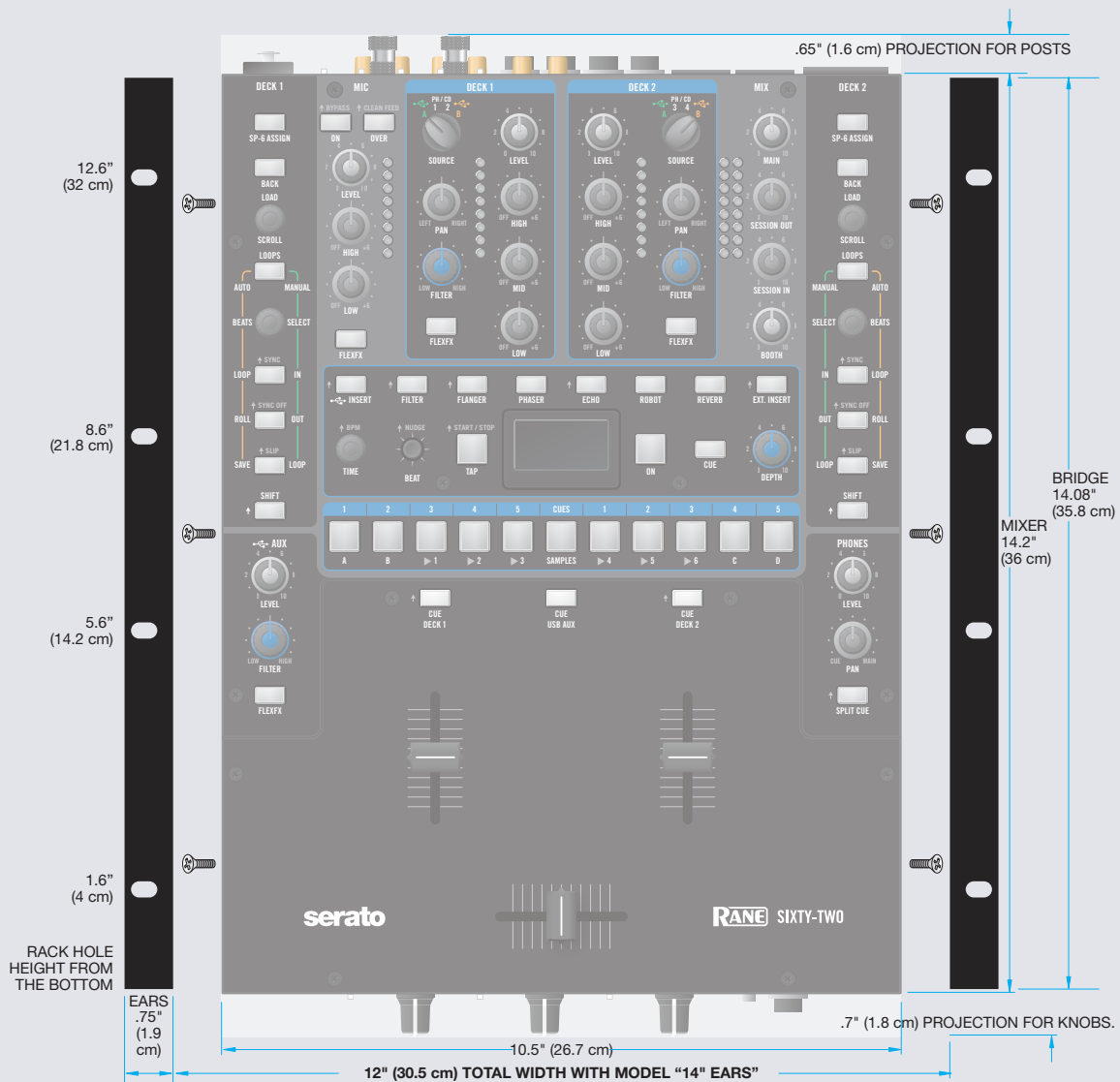

Declaration of Conformity

Application of Council Directives:

2001/95/EC 2002/96/EC
 2004/108/EC 2006/95/EC
 2011/65/EU

Standard(s) to which conformity is declared:

EN60065: 2002/A1:2006/A11:2008/A2:2010/A12:2011
 EN55103-1:2009
 EN55103-2:2009
 EN50581:2012
 ENVIRONMENT E2
 SERIAL NUMBERS 850000 - 950000
 CE MARK FIRST AFFIXED IN: 2012

Manufacturer:

Rane Corporation
10802 47th Avenue West
Mukilteo WA 98275-5000 USA

This equipment has been tested and found to be in compliance with all applicable standards and regulations applying to the EU's Low Voltage (LV) directive 2006/95/EC and Electromagnetic Compatibility (EMC) directive, 2004/108/EC. In order for the customer to maintain compliance with this regulation, high quality shielded cable must be used for interconnection to other equipment. Modification of the equipment, other than that expressly outlined by the manufacturer, is not allowed under this directive. The user of this equipment shall accept full responsibility for compliance with the LV directive and the EMC directive in the event that the equipment is modified without written consent of the manufacturer. This declaration of conformity is issued under the sole responsibility of Rane Corporation.

Type of Equipment: Professional Audio Signal Processing

Brand: Rane

Model: Sixty-Two, Sixty-Two Z

Immunity Results:

THD+N: 4 dBu, 400 Hz, BW 20 Hz - 20 kHz

Test Description

Measurement Conditions

RF Electromagnetic Fields Immunity

80 MHz -1000 MHz, 1 kHz AM, 80% depth, 3V/m <-72 dB
 1400 MHz - 2700 MHz, 1 kHz AM, 80% depth, 3V/m <-72 dB

Conducted RF Disturbances Immunity

150 kHz - 80 MHz, 1 kHz AM, 80% depth, 3V rms <-71 dB

Magnetic Fields Immunity

50 Hz - 10 kHz, 3.0 - 0.3 A/m <-75 dB

Common Mode Immunity (Signal Ports)

Bandpass re: 4 dBu, 1/3-octave

50 Hz - 10 kHz, -20 dBu <-69 dB

I, the undersigned, hereby declare that the equipment specified above conforms to the Directive(s) and Standard(s) shown above.



(Signature)

Greg Frederick

 (Full Name)

Compliance Engineer

 (Position)

January 25, 2012

 (Date)

Mukilteo WA USA

 (Place)

Limited Warranties

Factory Authorized Service

Your unit may someday need to be serviced by the Rane Factory if you live in the USA. International customers should contact your dealer or distributor for service. You must call the Rane factory before shipping. Please do not return your unit to Rane without prior authorization.

To obtain service or a Return Authorization in the USA, please phone Rane Corporation at 425-355-6000, or fax Rane at 425-347-7757.

Limited U.S.A. Warranty

RANE CORPORATION WARRANTS ALL RANE PRODUCTS (except those items classified and listed in "Wear Parts" on page 3) PURCHASED IN THE U.S. AGAINST DEFECTS IN MATERIAL OR WORKMANSHIP FOR A PERIOD OF TWO (2) YEARS. WEAR PARTS ARE LIMITED TO A PERIOD OF NINETY (90) DAYS FROM THE INITIAL DATE OF RETAIL PURCHASE FROM AN AUTHORIZED RANE DEALER—WEAR PARTS REQUIRE PROOF OF PURCHASE DATE. This limited warranty extends to all purchasers or owners of the product during the warranty period beginning with the original retail purchase. Rane Corporation does not, however, warrant its products against any and all defects: 1) arising out of material or workmanship not provided or furnished by Rane, or 2) resulting from abnormal use of the product or use in violation of instructions, or 3) in products repaired or serviced by other than the Rane Factory, or 4) in products with removed or defaced serial numbers, or 5) in components or parts or products expressly warranted by another manufacturer. Rane agrees to supply all parts and labor to repair or replace defects covered by this limited warranty with parts or products of original or improved design, at its option in each respect, if the defective product is shipped prior to the end of the warranty period to the Rane Factory in the original packaging or a replacement supplied by Rane, with all transportation costs and full insurance paid each way by the purchaser or owner.

Limited Warranty Outside the U.S.A.

RANE PRODUCTS ARE WARRANTED ONLY IN THE COUNTRY WHERE PURCHASED, THROUGH THE AUTHORIZED RANE DISTRIBUTOR IN THAT COUNTRY, AGAINST DEFECTS IN MATERIAL OR WORKMANSHIP, THE SPECIFIC PERIOD OF THIS LIMITED WARRANTY SHALL BE THAT WHICH IS DESCRIBED TO THE ORIGINAL RETAIL PURCHASER BY THE AUTHORIZED RANE DEALER OR DISTRIBUTOR AT THE TIME OF PURCHASE. Rane Corporation does not, however, warrant its products against any and all defects: 1) arising out of materials or workmanship not provided or furnished by Rane, or 2) resulting from abnormal use of the product or use in violation of instructions, or 3) in products repaired or serviced by other than authorized Rane repair facilities, or 4) in products with removed or defaced serial numbers, or 5) in components or parts or products expressly warranted by another manufacturer. Rane agrees, through the applicable authorized distributor, to repair or replace defects covered by this limited warranty with parts or products of original or improved design, at its option in each respect, if the defective product is shipped prior to the end of the warranty period to the designated authorized Rane warranty repair facility in the country where purchased, or to the Rane factory in the U.S., in the original packaging or a replacement supplied by Rane, with all transportation costs and full insurance paid each way by the purchaser or owner.

ALL REMEDIES AND THE MEASURE OF DAMAGES ARE LIMITED TO THE ABOVE SERVICES, IT IS POSSIBLE THAT ECONOMIC LOSS OR INJURY TO PERSON OR PROPERTY MAY RESULT FROM THE FAILURE OF THE PRODUCT; HOWEVER, EVEN IF RANE HAS BEEN ADVISED OF THIS POSSIBILITY, THIS LIMITED WARRANTY DOES NOT COVER ANY SUCH CONSEQUENTIAL OR INCIDENTAL DAMAGES. SOME STATES OR COUNTRIES DO NOT ALLOW THE LIMITATIONS OR EXCLUSION OF INCIDENTAL OR CONSEQUENTIAL DAMAGES, SO THE ABOVE LIMITATION MAY NOT APPLY TO YOU.

ANY AND ALL WARRANTIES, EXPRESS OR IMPLIED, ARISING BY LAW, COURSE OF DEALING, COURSE OF PERFORMANCE, USAGE OF TRADE, OR OTHERWISE, INCLUDING BUT NOT LIMITED TO IMPLIED WARRANTIES OF MERCHANTABILITY AND FITNESS FOR A PARTICULAR PURPOSE, ARE LIMITED TO A PERIOD OF TWO (2) YEARS FROM EITHER THE DATE OF ORIGINAL RETAIL PURCHASE OR, IN THE EVENT NO PROOF OF PURCHASE DATE IS AVAILABLE, THE DATE OF MANUFACTURE, SOME STATES OR COUNTRIES DO NOT ALLOW LIMITATIONS ON HOW LONG AN IMPLIED WARRANTY LASTS, SO THE ABOVE LIMITATIONS MAY NOT APPLY TO YOU. THIS LIMITED WARRANTY GIVES YOU SPECIFIC LEGAL RIGHTS, AND YOU MAY ALSO HAVE OTHER RIGHTS WHICH VARY FROM STATE TO STATE, COUNTRY TO COUNTRY.

Warranty Procedure - Valid in U.S.A. only

NOTICE! You must complete and return the warranty card or register your product online to extend the Warranty from 2 years to 3 years!

TO VALIDATE YOUR EXTENDED WARRANTY: Use the postcard that came in the box with your unit, or go to the **support** page at dj.rane.com and click on **product registration**. Fill out the warranty completely, being sure to include the model and serial number of the unit since this is how warranties are tracked. If your Rane product was purchased in the U.S.A., mail the completed card or register online with to Rane Corporation within 10 days from the date of purchase. **If you purchased the product outside the U.S.A. you must file your warranty registration with the Rane Distributor in that country.** It is advised that you keep your bill of sale as proof of purchase, should any difficulties arise concerning the registration of the warranty card. **NOTICE: IT IS NOT NECESSARY TO REGISTER IN ORDER TO RECEIVE RANE CORPORATION'S STANDARD TWO YEAR LIMITED WARRANTY.**

WARRANTY REGISTRATION is made and tracked by MODEL AND SERIAL NUMBERS ONLY, not by the purchaser's or owner's name. Therefore any warranty correspondence or inquires **MUST** include the model and serial number of the product in question. Be sure to fill in the model and serial number in the space provided below and keep this in a safe place for future reference.

WARRANTY SERVICE MUST BE PERFORMED ONLY BY AN AUTHORIZED RANE SERVICE FACILITY LOCATED IN THE COUNTRY WHERE THE UNIT WAS PURCHASED, OR (if product was purchased in the U.S.) AT THE RANE FACTORY IN THE U.S.. If the product is being sent to Rane for repair, please call the factory for a Return Authorization number. We recommend advance notice be given to the repair facility to avoid possible needless shipment in case the problem can be solved over the phone. **UNAUTHORIZED SERVICE PERFORMED ON ANY RANE PRODUCT WILL VOID ITS EXISTING FACTORY WARRANTY.**

FACTORY SERVICE: If you wish your Rane product to be serviced at the factory, it must be shipped **FULLY INSURED, IN THE ORIGINAL PACKING OR EQUIVALENT**. This warranty will **NOT** cover repairs on products damaged through improper packaging. If possible, avoid sending products through the mail. Be sure to include in the package:

1. Complete return street shipping address (P.O. Box numbers are **NOT** acceptable).
2. A detailed description of any problems experienced, including the make and model numbers of any other system equipment.
3. Remote power supply, if applicable.

Repaired products purchased in the U.S. will be returned prepaid freight via the same method they were sent to Rane. Products purchased in the U.S., but sent to the factory from outside the U.S. **MUST** include return freight funds, and the sender is fully responsible for all customs procedures, duties, tariffs and deposits.

In order to qualify for Rane's one year extended warranty (for a total of 3 years parts and labor), the warranty must be completely filled out and sent to us immediately. Valid in USA only.

We recommend you write your serial number here in your owners manual and on your sales receipt for your records.

SERIAL NUMBER: _____ PURCHASE DATE: _____

dj.rane.com is your center for support, accessories, community, and learning how to get the most from your Sixty-Two Mixer.