

# **RANE SIXTY-EIGHT MIXER MANUAL**

## Important Safety Instructions

1. Read these instructions.
  2. Keep these instructions.
  3. Heed all warnings.
  4. Follow all instructions.
  5. Do not use this apparatus near water.
  6. Clean only with a dry cloth.
  7. Do not block any ventilation openings. Install in accordance with manufacturer's instructions.
  8. Do not install near any heat sources such as radiators, registers, stoves, or other apparatus (including amplifiers) that produce heat.
  9. Do not defeat the safety purpose of the polarized or grounding type plug. A polarized plug has two blades with one wider than the other. A grounding-type plug has two blades and a third grounding prong. The wide blade or third prong is provided for your safety. If the provided plug does not fit into your outlet, consult an electrician for replacement of the obsolete outlet.
  10. Protect the power cord and plug from being walked on or pinched particularly at plugs, convenience receptacles, and the point where it exits from the apparatus.
  11. Only use attachments & accessories specified by Rane.
  12. Use only with the cart, stand, tripod, bracket, or table specified by the manufacturer, or sold with the apparatus. When a cart is used, use caution when moving the cart/apparatus combination to avoid injury from tip-over.
  13. Unplug this apparatus during lightning storms or when unused for long periods of time.
  14. Refer all servicing to qualified service personnel. Servicing is required when the apparatus has been damaged in any way, such as power supply cord or plug is damaged, liquid has been spilled or objects have fallen into the apparatus, the apparatus has been exposed to rain or moisture, does not operate normally, or has been dropped.
  15. The plug on the power cord is the AC mains disconnect device and must remain readily operable. To completely disconnect this apparatus from the AC mains, disconnect the power supply cord plug from the AC receptacle.
  16. This apparatus shall be connected to a mains socket outlet with a protective earthing connection.
  17. When permanently connected, an all-pole mains switch with a contact separation of at least 3 mm in each pole shall be incorporated in the electrical installation of the building.
  18. If rack-mounting, provide adequate ventilation. Equipment may be located above or below this apparatus, but some equipment (like large power amplifiers) may cause an unacceptable amount of hum or may generate too much heat and degrade the performance of this apparatus.
- WARNING:** To reduce the risk of fire or electric shock, do not expose this apparatus to rain or moisture. Apparatus shall not be exposed to dripping or splashing and no objects filled with liquids, such as vases, shall be placed on the apparatus.

## Warning



To reduce the risk of electrical shock, do not open the unit. No user serviceable parts inside. Refer servicing to qualified service personnel. The symbols shown below are internationally accepted symbols that warn of potential hazards with electrical products.



This symbol indicates that there are important operating and maintenance instructions in the literature accompanying this unit.



This symbol indicates that a dangerous voltage constituting a risk of electric shock is present within this unit.

These stickers are located on the bottom of the mixer.

**WARNING:** This product may contain chemicals known to the State of California to cause cancer, or birth defects or other reproductive harm.

## FCC Statement

This equipment has been tested and found to comply with the limits for a Class B digital device, pursuant to part 15 of the FCC Rules. These limits are designed to provide reasonable protection against harmful interference in a residential installation. This equipment generates, uses and can radiate radio frequency energy and, if not installed and used in accordance with the instructions, may cause harmful interference to radio communications. However, there is no guarantee that interference will not occur in a particular installation. If this equipment does cause harmful interference to radio or television reception, which can be determined by turning the equipment off and on, the user is encouraged to try to correct the interference by one or more of the following measures:

- Reorient or relocate the receiving antenna.
- Increase the separation between the equipment and receiver.
- Connect the equipment into an outlet on a circuit different from that to which the receiver is connected.
- Consult the dealer or an experienced radio/TV technician for help.

**CAUTION:** Changes or modifications not expressly approved by Rane Corporation could void the user's authority to operate the equipment.

This Class B digital apparatus complies with Canadian ICES-003.

Cet appareil numérique de la classe B est conforme à la norme NMB-003 du Canada.

## Copyright Notices

©2013 Rane Corporation. All rights reserved. Serato DJ and Scratch Live are trademarks of Serato. Trademarked in the United States and other countries. This software is based in part on the work of the Independent JPEG Group, and uses libpng code, copyright © 2000-2002 Glenn Randers-Pehrson. The Serato NoiseMap™ Control Tone, the audio pressed on Serato Control vinyl and Control CDs, is copyright ©2004-2013 Serato. The Control Vinyl and Control CDs are licensed for personal use only. The creation of personal backups of the Control CD is allowed, however duplicating Control CDs for commercial benefit is strictly prohibited. For avoidance of doubt the duplication or creation of Control vinyl for any use is strictly prohibited. Please respect our copyright. Windows® is a registered trademark of Microsoft Corporation in the United States and other countries. Apple, Mac, Macintosh, iTunes, Safari, QuickTime, GarageBand, and OS X are registered trademarks of Apple Inc., registered in the United States and other countries.

## Check List

**These items are included in the box:**

- **Sixty-Eight Mixer.**
- **Serato DJ software and drivers install disc.**
- **4 (four) control CDs.**
- **4 (four) control records.**
- **2 USB cables.**
- **IEC C5 line cord.**
- **Serato DJ Software Manual.**
- **This Sixty-Eight Mixer Manual.**

## Wear Parts

The Sixty-Eight Mixer contains no wear parts. The control vinyl records and CDs are wear parts as described in "Limited Warranties" on page 35.

**Contents**

**2 Important Safety Instructions**

**3 Check List**

**3 Wear Parts**

**5 Quick Start: Software**

- 5 Serato DJ Software Installation for Mac OSX
- 5 Serato DJ Software Installation for Windows
- 5 Serato Scratch Live

**6 Quick Start: Hardware**

- 7 Turntable Setup
- 7 CD Player Setup
- 7 Wiring

**7 Quick Start: Operation**

**9 Sixty-Eight Overview**

**10 Sixty-Eight Connections**

- 10 Power Supply
- 10 PGM Inputs 1-4
- 10 Mic Inputs
- 10 Analog Outputs

**11 Mixer Controls**

- 11 Four Program Input Channels
- 11 Crossfader
- 12 Mics
- 12 Main Mix
- 12 Headphones

**13 Control Strip Controls**

- 13 Layer / Shift
- 13 Control Point
- 13 Channel Control Strips
- 13 Back
- 13 Scroll Crate / Load A / B
- 13 Loop: Manual / Auto
- 14 Manual Loop Controls
- 14 Auto Loop Controls
- 14 Cue Points
- 14 Delete

**15 FlexFx**

**16 Internal Audio Effects**

- 17 Effects Parameter Table

**18 USB Audio**

**20 Core Audio and ASIO Drivers**

**22 MIDI Mapping**

**27 DJ Changeover**

**28 Technical Specifications**

**29 Mounting Bracket Accessories**

**31 Fader Maintenance**

**33 Signal Processing Block Diagram**

**34 Declaration of Conformity**

**35 Limited Warranties**

## Quick Start: Software

Before using your Sixty-Eight, at least read this short section for the basics. Read the complete manual to get the best investment from your new Sixty-Eight. This section will help get you started with one computer.

### Serato DJ Software Installation for Mac OSX

Before installing, we recommend you check for a newer version of Serato DJ at [serato.com/downloads](http://serato.com/downloads) and install the latest Serato DJ version if it is newer than the version on the CD-ROM that comes with your mixer.



1. Insert the Serato DJ Installer CD-ROM that came with your unit,  
-or-  
browse using Finder to the location where the Serato DJ download was saved.
2. Double click the Serato DJ .dmg installer file.
3. The software EULA screen will appear - read the License Agreement, then click Agree.
4. The disk image mounts and opens the actions folder, once this is finished you can unmount the disk image and launch Serato DJ.
5. Drag the Serato DJ application icon to the Applications folder alias.
6. You may then need to enter your User Password to authenticate.
7. Serato DJ will now copy to the Applications folder, once this is finished you can unmount the disk image and launch Serato DJ.

### Serato DJ Software Installation for Windows

Before installing, we recommend you download and install the latest Serato DJ version from [serato.com](http://serato.com) if it is newer than the version on the CD-ROM that comes with your mixer.

1. Insert the Serato DJ Installer CD-ROM that came with your unit,  
-or-  
browse using Windows Explorer to the location where the Serato DJ download installer was saved.
  2. Double click the Serato DJ .exe installer file.
  3. Accept the Security Warning and click "Run".
  4. The installer introduction screen will appear, click Next.
  5. Read the License Agreement, then tick "I agree to the license terms and conditions," then click Install.
  6. If a User Account Control window appears, click Yes.
  7. Serato DJ will now perform a standard installation.
  8. The installation is now complete. You can now click Close.
- NOTE: A shortcut will be also be created on desktop.

**When you first connect your Sixty-Eight Mixer via USB,** you may see a request to install drivers.

Accept the request and allow the driver installation to proceed. After drivers are installed, a Sixty-Eight control panel will be available, and your software will recognize the Sixty-Eight.

After Serato DJ is installed, you will be prompted to "Install Driver" in the Online Panel if you connect a new compatible device that has not already had its driver installed.

### Serato Scratch Live

Your Sixty-Eight is also completely compatible with Serato Scratch Live. You may connect to a laptop that has either program installed. **If you would like to continue using Scratch Live, you can download the Sixty-Eight Manual for Serato Scratch Live at either [serato.com](http://serato.com) or [dj.rane.com](http://dj.rane.com).**

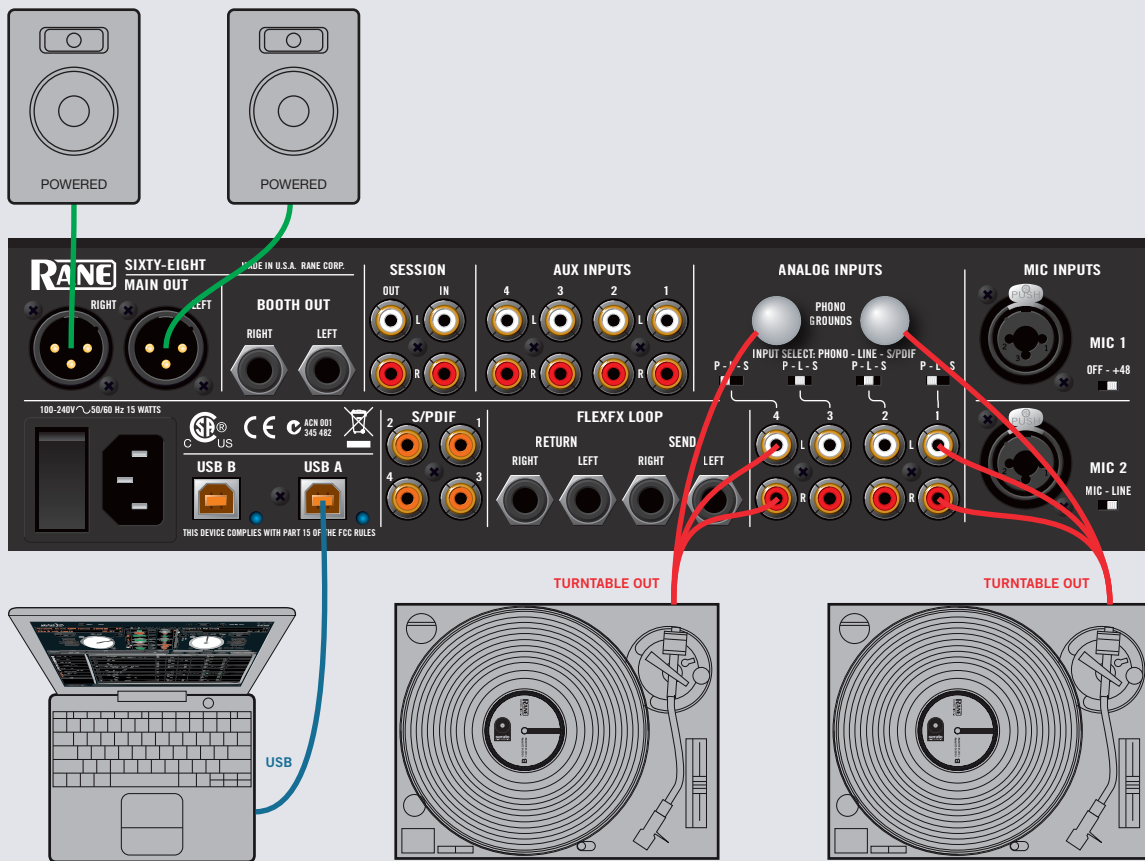

## Quick Start: Hardware

This section will help you get your decks connected and music playing. Turn the power off while connecting your decks and amplifiers.

### 1. Inputs

Connect your CD players or turntables to the ANALOG INPUTS on the Sixty-Eight. If your CD players have S/PDIF outputs, connect these to the S/PDIF inputs on the Sixty-Eight. We recommend connecting decks left of the mixer to 1 and 2, and decks on the right to 3 and 4.

Match the L channel from each of your decks (usually white) with the white (uppermost) RCA sockets on the mixer and R (usually red) with the red sockets. This is important to give Serato DJ the correct direction of playback. If your songs play backwards, you probably have the left and right channels swapped from your deck.

### 2. Input Level Selection

Set each input to the correct input level using the P - L - S switches. P = Phono, L = Line (for CD players) and S = S/PDIF. Unused inputs are best set to L.

### 3. USB Audio

Select Serato DJ as the audio source for a channel by turning a PGM SOURCE knob to a  USB input. Any of the four analog inputs may be used for Serato DJ vinyl emulation control. Control input sources are selected in Serato DJ software.

## 4. Connect a Sixty-Eight USB

Using the provided USB cable, connect either USB A or USB B to an available USB 2.0 port on your computer. The Sixty-Eight automatically switches its control point if only one of the USB ports is connected. Make sure you connect it directly to your computer and not through a hub or splitter.

### Turntable Setup

1. Set the tone arms to the specific recommendations of the cartridge used, so that the needle never leaves the record, but not heavy enough that it heats up significantly. Both produce poor tracking.
2. Grounding is extremely important when using Serato DJ. Make sure you have good connections from the ground wires of your turntables to a grounding post on the Sixty-Eight. If you do not ground your turntables properly, the control signal will be noisy and the tracking of the record position will be erratic.

### CD Player Setup

Disable all built-in effects on the CD player, including keylock/master tempo.

### Wiring

Rane recommends balanced wiring for the strongest signal and rejection of hum and noise. If your cable to the destination is less than 10 feet (3 meters), you can often get away with an unbalanced cable. See the RaneNote "[Sound System Interconnection](#)" at [rane.com](#) for cable wiring recommendations.

## Quick Start: Operation

### Primary & Secondary Deck Layers

When using the Sixty-Eight with more than two Virtual Decks, layers are used to determine which Decks respond to keyboard shortcuts and the Control Strips on the Sixty-Eight. The Primary Deck layer is the main left and right Decks that you will use, while the Secondary Deck layer is the other secondary Decks. You decide which Decks are to be the Primary and Secondary Decks, this can be configured in Serato DJ. Click the SETUP button at the top of the screen, and settings are in the Audio tab. Refer to the Serato DJ Manual.

To switch focus between the Primary and Secondary Deck layers, use the **LAYER** button on the Sixty-Eight.

### Calibrating Serato DJ for Control Vinyl or CD

Since Serato DJ is controlled by an analog signal, there is no guarantee of what state that signal will be in by the time the software gets to interpret it. Therefore, Serato DJ needs to be able to handle a wide range of signals, and be configurable to use them optimally. Calibrating is just configuring the software to your situation. Calibration is equally important for both vinyl and CD users of Serato DJ.

There are two parts to the Serato DJ Control Vinyl: The directional tone, and the NoiseMap™. Listening to the control vinyl, the directional tone is the 1 kHz tone. The noise map sounds like random noise over the top of the tone. The directional tone provides the current speed and direction of the record, while the noise map tells the software precisely where on the record the needle is currently.

The Noise Sensitivity slider lets you adjust the noise threshold. A threshold is a lower limit, below which a process will not occur. In the case of Serato DJ, the noise threshold is the limit below which the input signal will not be interpreted as control signal; in other words if it's below the threshold, it is considered noise and ignored.

This setting is necessary because a stylus is very sensitive, and will inevitably pick up noise from the environment as well as the signal on the record, especially in the noisy environment of a live show.

### How To Calibrate Serato DJ

With music playing in the background through your system or booth output, put your needle on the record with the turntable stopped. If you are using CD players, the same rules apply. Have the CD deck paused or stopped while calibrating.

Click and hold the estimate button until the slider stops moving. Moving the Noise Sensitivity slider to the left will make Serato DJ more sensitive to slow record movement, but also more sensitive to background noise.

Repeat the process for each deck.

Things to remember:

- Your needle must be on the record.
- Your turntable (or CD player) must be stationary.
- The background music playing must be at a similar level to which you will play your set at.
- Calibrate Serato DJ every time you play.

TIP: If the slider jumps to the far right, then you have a problem with noise in your turntables/CD players/mixer. Check all your connections and make sure your equipment is well earthed. In some situations you will not be able to improve the signal quality, and you will have to play on regardless. In this situation, stick to rel mode.



### The Scopes

The scopes on the setup screen in Serato DJ display the input signal as a phase diagram. The key factors to look at on the scope display are crisp clean lines, round shape, and the tracking percentage in the lower right corner.

Start both turntables or CD players. You will see green rings appear in the scope view, as shown above.

For optimal performance the inner ring should be as close to circular as possible. Use the scope zoom slider to zoom in or out as necessary. Use the scope L/R balance and P/A balance controls to adjust the shape of the inner ring. The number in the top left corner of the scope view gives the current absolute position within the control record or CD. The number in the top right corner is the current speed in RPM. In the bottom left is the current threshold setting, and the number in the bottom right shows the percentage of readable signal – this number should be close to 85% when your system is calibrated properly.

**For complete software operating instructions, see the Serato DJ Manual.**



## Sixty-Eight Overview

### Software controls are built-in for one or two computers

- Includes Serato DJ software.
  - Includes Rane ASIO and Core Audio Drivers for Serato DJ and other audio programs.
  - Control Library, Cues, Loops and Samples from the mixer on two computers.
- Each of the two USB ports supports six stereo record and five stereo playback channels.
- USB record channels support:
  - Vinyl control signal for four Virtual Decks, or record any one of the four Decks post-fader.
  - Record the Main Mix, Mic 1 or Mic 2.
  - FlexFX USB Insert Send to each computer.
- USB playback channels support:
  - Playback for four Virtual Decks.
  - FlexFX USB Insert Return from each computer.

Mic 1 allows +48 volt switchable phantom power. Mic 2 allows switchable Mic or Line-level input. Both Mics have 2-band full-cut tone controls. Either Mic can route to FlexFX or record to USB.

Four Program buses, each includes:

- Four Phono - Line - S/PDIF Inputs.
- Four Aux Line Inputs.
- Four USB playback Inputs.

Two USB ports, each with six stereo record channels and five stereo playback channels simultaneously available, allows two DJs with their own laptops to share the mixer.

The outer strips directly control Serato Scratch Live functions such as Cue Points, Loops, Track Library, and recalling custom Groups.

In Auto mode, Loop buttons use the Scratch Live auto-loop, lighting the buttons green. In Manual mode, Loop buttons use manual looping features, lighting the buttons orange. Select knob adjusts the loop length.

FlexFX are stackable:

- Six internal effects with seamless on-beat switching between effects.
- External Insert engages the external analog Effects Loop.
- ↵ 5 Insert engages software effects through USB.

Recall Cue Points with "Hot Cue" behavior supported in Scratch Live.

The Control Point button selects the USB port in control of the control strips.

Back buttons shift between crates & tracks. Scroll knob scrolls crates & tracks, click it to load the track to a deck.

Program buses include 3-band full-cut tone controls plus sweepable Low-pass / High-pass cut filters.

Level controls on each Output:

- Main Output on XLR jacks
- Booth Output on 1/4" TRS
- Session Output on RCA

True Split Cue for any Program bus or the FlexFX submix with effects to the front panel 1/4" and 3.5 mm headphone jacks.

The FlexFx Loop can create a sub-mix with any combination of the four Program buses and two Mics, and then add internal or external effects. This submix may be recorded via the USB Send, or output by the analog FlexFx Loop Send.

Controls the level of the FlexFx signal to the Main Mix.

Supports 2, 3 or 4 Virtual Decks in Serato Scratch Live on one or two computers.

Contour controls adjust faders and the Crossfader for a smooth transition or a fast cut.

The Crossfader is a no-noise, no-bleed magnetic fader.

Record to USB from any Program bus, any Mic or the Main Output.



## Sixty-Eight Connections

### Power Supply

The Sixty-Eight Mixer features an internal universal switching power supply that operates on any AC mains 100 to 240 VAC, 50 or 60 Hz (most places in the world). All that is required when traveling is the appropriate IEC line cord, available from a local electronics store. The universal supply is a major plus for the traveling DJ. Though this mixer has turn on/off muting, it's smart to leave the power unplugged until everything else is connected.

### PGM Inputs 1-4

The Sixty-Eight has four stereo analog inputs for PGM 1 through PGM 4. Any of these analog inputs may be set for Phono Input, Line Input or S/PDIF using the **P - L - S** switches located on the rear panel. Unused inputs are best set to LINE. Attach your turntable's ground wires to the Phono Ground connectors.

Any of the four analog inputs may be used for Serato DJ vinyl emulation control. Input 1 or Input 2 may be selected for Serato DJ Virtual Deck 1 or 2 control. Input 3 or Input 4 may be selected for Serato DJ Virtual Deck 3 or 4 control. Control input sources are selected in Serato DJ software.

### Mic Inputs

The Mic Inputs will accept an XLR 3-pin plug, a balanced ¼" TRS (tip-ring sleeve) plug or an unbalanced TS (tip-sleeve) plug. Mic 1 has a switchable phantom power option, and Mic 2 has a switchable line level option.

### Analog Outputs

All analog outputs come from the same "Main Mix" signal. Main, Booth and Session outputs each have their own Level control. The Main output is on balanced XLR jacks with pin 2 "hot" per AES standards. The Booth output is on balanced ¼" TRS (tip-ring-sleeve) jacks, though unbalanced TS (tip-sleeve) plugs may be used. The Session output is on regular unbalanced RCA jacks. Because all signals are identical, users may use any of these outputs as the "main" output if a different cable type is required for system connection.

Rane recommends balanced wiring for the strongest signal and rejection of hum and noise. If your cable to the amp rack is less than 10 feet (3 meters), you can usually get away with an unbalanced cable. See the RaneNote "[Sound System Interconnection](http://www.rane.com)" at rane.com for details and cable wiring.

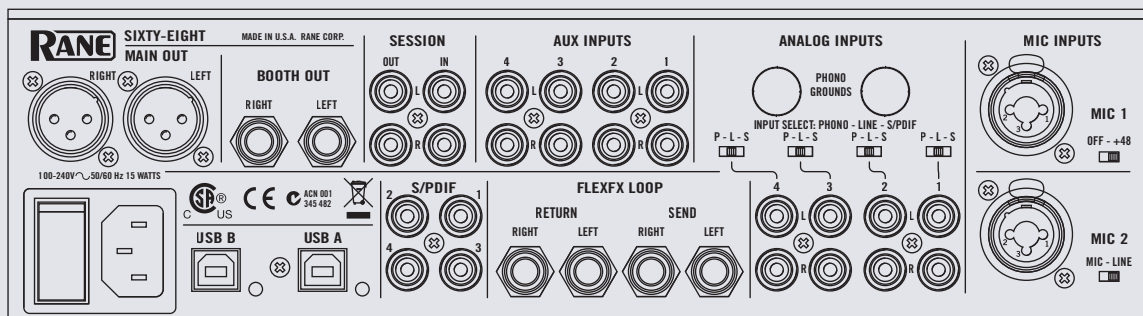

## Mixer Controls

### Four Program Input Channels

#### PGM 1 and PGM 2 SOURCE selection:

- Phono/CD 1 (Phono or Line or S/PDIF)
- Phono/CD 2 (Phono or Line or S/PDIF)
- USB Playback 1
- USB Playback 2
- Auxiliary 1
- Auxiliary 2

#### PGM 3 and PGM 4 SOURCE selection:

- Phono/CD 3 (Phono or Line or S/PDIF)
- Phono/CD 4 (Phono or Line or S/PDIF)
- USB Playback 3
- USB Playback 4
- Auxiliary 3
- Auxiliary 4

Note: **PHONO** or **LINE** or **S/PDIF** is individually selected for each of the four Phono/CD inputs using the rear panel dip switches. S/PDIF inputs support PCM audio only at sample rates from 44.1 kHz to 96 kHz.

#### Source Selection is followed by:

- **LEVEL** gain trim is Off to +12 dB, with unity gain at 12 o'clock.
- **HIGH / MID / LOW** 3-band, full-cut EQ range is Off to +6 dB, with unity gain at 12 o'clock.
- **LOW-PASS / HIGH-PASS FILTER:**
  - Flat response is in the center.
  - Low-pass filter cut-off moves from 20 kHz toward 20 Hz as the knob is turned counter-clockwise.
  - High-pass filter cut-off moves from 20 Hz toward 20 kHz as the knob is turned clockwise.
- **CROSSFADER** assigns the channel to **A**-side, **POST** or **B**-side.
- **FLEXFX** assign takes the channel out of the Main Mix and sends it to the FlexFx Loop.
- **CUE** select assigns the channel to the headphone monitor.
- Each of the four channels has a mono rms signal level meter with peak-hold.

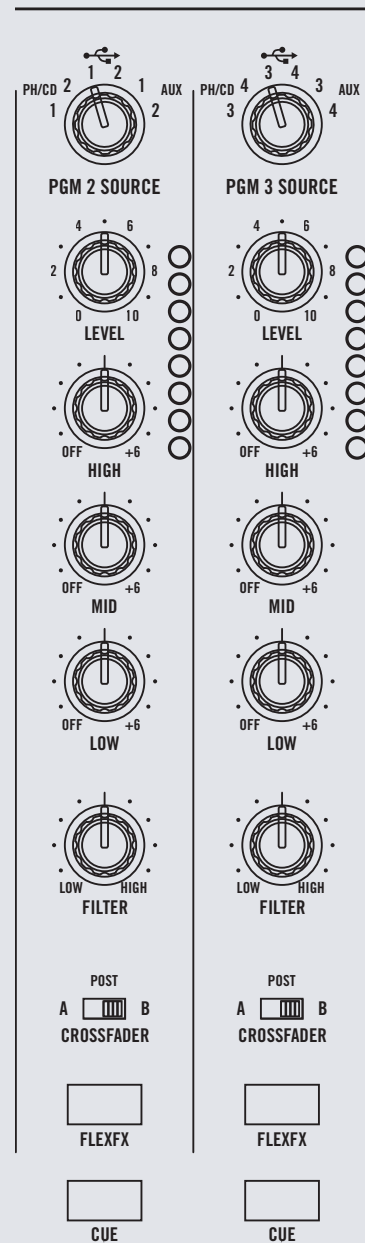
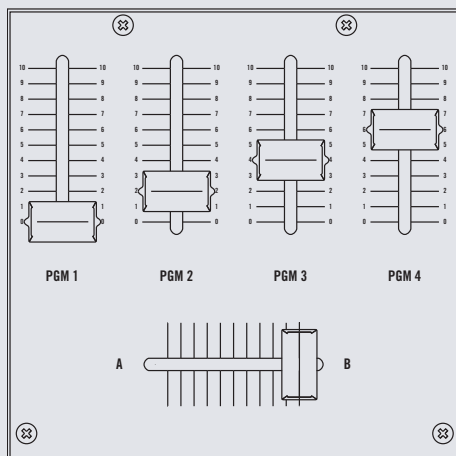

**CONTOUR CONTROLS** for the **PGM FADERS** on the front panel affect all four channel faders.

#### Crossfader

- Assign each PGM channel to the **A**-side, **B**-side or **Post-Crossfader** with the **CROSSFADER** switches.
- No-noise, no-bleed magnetic fader.
- Easily field-replaceable. See Appendix.
- Adjust the **CROSSFADER CONTOUR** with the front panel **CROSSFADER** control.

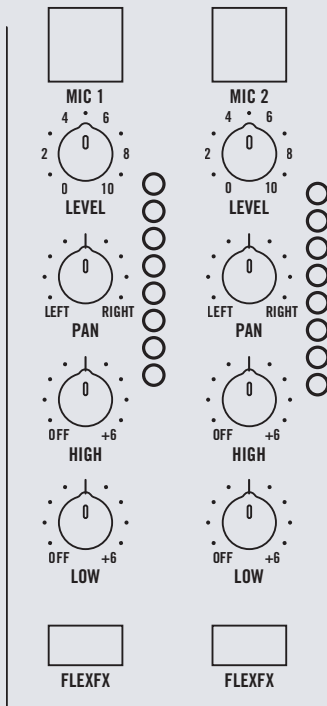

**Mics**

Two Microphone Inputs are fully independent, each with these controls:

- Large illuminated On / Off switch.
- **LEVEL** control.
- **PAN** the signal from left to right.
- **HIGH / LOW** 2-band, full-cut EQ range is Off to +6 dB with unity gain at 12 o'clock.
- **FLEXFX** Assign takes the signal out of the Main Mix and sends it to the FlexFx Loop.
- **MIC 1** allows +48 volt phantom power with a rear panel switch.
- **MIC 2** allows selection of **MIC** or **LINE**-level input with a rear panel switch.

**Main Mix**

The Main Mix is made from these signals:

- PGM 1, PGM 2, PGM 3, PGM 4
- Mic 1, Mic 2
- Session Input
- FlexFx Mix

**The Main Mix has these outputs:**

- **MAIN**
  - Balanced XLR jacks.
  - Maximum output 8 volts rms.
  - Stereo rms meter with peak-hold.
- **BOOTH**
  - Balanced 1/4" TRS jacks.
  - Maximum output 8 volts rms.
- **SESSION**
  - Unbalanced RCA jacks.
  - Maximum output 4 volts rms.
- Independent controls common to all Main Mix outputs:
  - **LEVEL** controls with a range of Off to 0 dB.
  - **BALANCE** Left/Right control.
  - **MONO** switch.

**Headphones**

The Headphone Monitor provides stereo or mono split-cue operation.

- In Stereo operation, the **PAN** control pans between stereo Cue and stereo Main Mix.
- In Split Cue operation, the **PAN** control pans between Mono Cue in the left ear and mono Main Mix in the right ear.
- Individual **CUE** buttons are provided for **PGM 1, PGM 2, PGM 3, PGM 4** and the **FLEXFX** Loop.
- The Headphone Level control sets the level in the both of the front panel 3.5 mm and 1/4" output jacks.

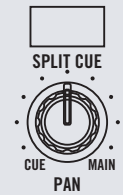
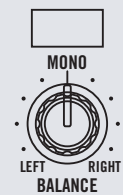

## Control Strip Controls



LAYER / SHIFT



BACK

SCROLL



LOAD A



MANUAL



AUTO



LOOPS



SELECT



IN



LOOP



OUT



ROLL



LOOP



SAVE



DELETE



1



2



3



4



5

CUE POINTS

### Layer / Shift

The **LAYER** button allows you to select which of the Virtual Decks the control strips are in command of. Pressing this button toggles between the assigned Primary and Secondary Deck Layers as chosen in Serato DJ. See "Select Primary Decks" in the Serato DJ Manual.

The **SHIFT** button allows you to switch between the five groups on the Sixty-Eight.

Group 1 is the default and allows use of the standard preset functionality of the Sixty-Eight. The other four groups have no preset functions, so you can customize and configure them to your liking.

Hold the **SHIFT** button and press **CUE** buttons 1 through 5 to select a group. If you are in groups 2 to 5 you can then use the MIDI Learn function in Serato DJ to assign the controls on the Sixty-Eight to functions in Serato DJ. See "MIDI Mapping" on page 22.

**NOTE: The Sixty-Eight always defaults to group 1 on startup.**

### Control Point

Press to select which connected computer is in control of the Sixty-Eight's control strips. The LED light indicates which computer is selected.

### Channel Control Strips

The Sixty-Eight has identical control strips for the left and right Virtual Deck. Each performs the same CUE functions but for the left and right Deck respectively.

### Back

Switches the focus between the Crate and Library area in Serato DJ. If you have any panels open in Serato DJ, the **BACK** button will also move the focus between this and the Crate and Library areas.

### Scroll Crate / Load A / B

Rotate the knob to scroll through the Crate /Library Panel which currently has focus in Serato DJ.

When the focus is in the Crate area, pressing the knob will display the contents of the selected crate and move the focus into the Library area.

When the focus is in the Library area, pressing the knob will load the selected track to the respective Virtual Deck.

### Loop: Manual / Auto

The **MANUAL / AUTO** button toggles the state of the Loop Controls between Manual and Auto Loop mode.

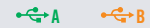

CONTROL POINT



BACK

SCROLL



LOAD B



MANUAL



AUTO



LOOPS



SELECT



IN



LOOP



OUT



ROLL



LOOP



SAVE



DELETE



1



2



3



4



5

CUE POINTS

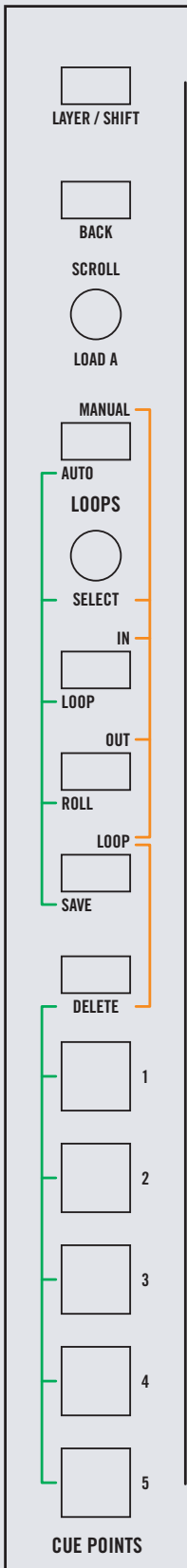

**Manual Loop Controls**

Manual Loop mode on the Sixty-Eight allows control of the manual looping features of Serato DJ. When **MANUAL** Loop mode is selected, the loop control buttons will be **illuminated orange** to correspond with the orange manual loop labeling on the Sixty-Eight.

**SELECT** - Selects a loop slot in Serato DJ.

**IN** - Sets a loop in point.

**OUT** - Sets a loop out point.

**LOOP** - Turns a loop on or off.

**DELETE** - Allows you to delete a loop. Press **DELETE** and the Loop button now glows orange. Next, use the **SELECT** knob to select the loop to be deleted, then press the flashing **LOOP** button.

**Auto Loop Controls**

Auto loop mode on the Sixty-Eight allows control of the auto looping features of Serato DJ. When **AUTO** loop mode is selected, the loop control buttons will be **illuminated green** to correspond with the green auto loop labeling on the Sixty-Eight.

**SELECT** - Selects the auto loop length in Serato DJ. This can be adjusted while an auto loop is already looping as an effect.

**LOOP** - Performs an auto loop of the value selected.

**ROLL** - Performs a loop roll of the value selected.

**SAVE** - Saves the current loop to an available loop slot in Serato DJ.

**For more information on loop functions see the Serato DJ Manual.**

**Cue Points**

You can set and trigger cue points in Serato DJ by using the **CUE** buttons on the Sixty-Eight. Pressing a **CUE** button will trigger the corresponding set cue point in Serato DJ. If a corresponding cue does not exist, pressing a **CUE** button will set a new cue point.

**Delete**

You can delete a set cue point in Serato DJ by pressing and holding the **DELETE** button, then pressing the corresponding **CUE** button.

**For more information on cue functions see the Serato DJ Manual.**

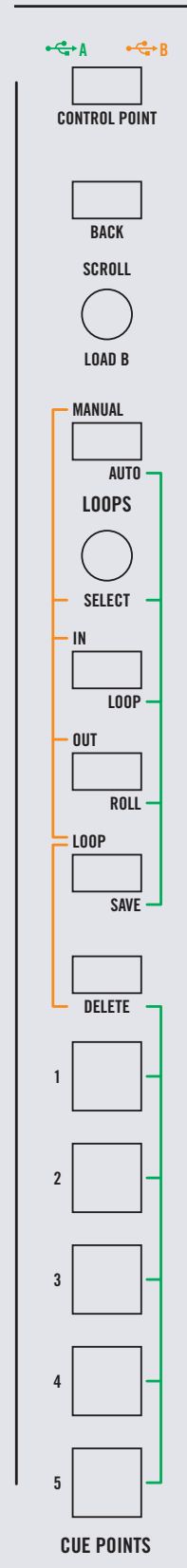

## FlexFx

The FlexFx Bus in the Sixty-Eight works differently than other basic effect insert solutions. The FlexFx Bus is more like an auxiliary bus that can have multiple signals assigned to it. Those combined signals can have internal effects, external analog effects and external USB effects applied in any combination. It is possible to cue and control the level of this auxiliary mix in the Main Mix. This architecture is very flexible and not just simply inserting an effect in a signal path and turning it on. So, it's important to understand the different control functions. The order of processing in the FlexFx Bus is:

- 1. FlexFx assign for each PGM and Mic.
- 2. Internal Effects
- 3. Ext. Analog Insert
- 4. USB Insert
- 5. Cue
- 6. FlexFx On
- 7. FlexFx Mix Level control.

These are shown with signal flow in the drawing below.

1. The **FLEXFX** buttons located in the PGM and MIC channels assign signal to the FlexFx Bus when on (blue), and to the Main Mix when off. This allows multiple inputs to the FlexFx Bus and allows drumming different signals into and out of an applied effect without interruption.
2. The six **EFFECT** buttons both turn on and sync an internal effect. By keeping this separate from the **FLEXFX ON** button, it is possible to turn on, sync and cue effects, before you hear them in the Main Mix. Only one internal effect is selected at a time. Having six independent buttons, it is possible to drum in different effects all with independent beat multipliers, without interruption.
3. **EXT. INSERT** is turned on/off with a separate button. The External Analog Insert can be used with internal effects and USB Insert or independently. This button will have no effect if there is no external processor connected to the **FLEXFX LOOP** jacks on the mixer. The FlexFx submix may be recorded via the analog **FLEXFX LOOP SEND**.
4. The USB Insert is turned on/off with the separate **5 INSERT** button. The external USB insert can be used with internal effects and analog insert or independently. The USB Insert uses USB record-5 and playback-5. The Send can serve as a USB audio output for recording a submix on a computer, or be used in conjunction with the USB Return to form an external USB effects loop. This loop feature eliminates gain structure issues associated with using Send and Return signals that are not co-located.

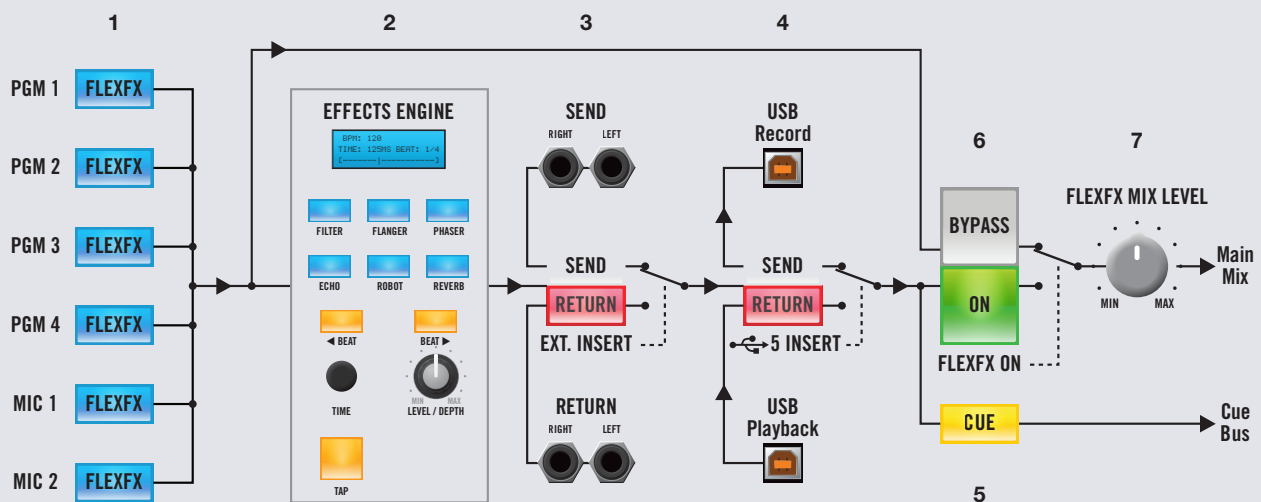

5. The FlexFX **CUE** is located after internal effects, analog External Insert and the USB 5 Insert. It is located before the FlexFx On and FlexFx Mix level. This allows the processed Bus signal (wet or dry) to be cued at any time.
6. The **FLEXFX ON** button, when off, effectively bypasses the FlexFx bus and passes assigned signals straight through to the Main Mix. What you hear in the main mix is a dry version of any signal assigned to the FlexFx Loop. This allows any combination of internal and external effects to be applied and cued before being heard in the Main Mix, without interrupting play of assigned dry signals. When you're ready to listen to the effected signal, engage the **FLEXFX ON** button (green). Any combination of the above controls can be left on with only one of them determining if an effect is applied or not. You get to choose.
7. The **FLEXFX MIX LEVEL** control (on the front of the mixer) allows you to control the level of the FlexFx Bus signal in the Main Mix. This control has nothing to do with the Level/Depth control for the internal effect or the mix of Wet/Dry. It performs the same function whether an effect is applied or not. This control serves one function: it keeps the FlexFx Bus out of the Main Mix so you can adjust effects before bringing them into the main mix.

If the **FLEXFX MIX LEVEL** control is turned up, and the **FLEXFX ON** button is Off (bypassed), there is no change in what is heard in the Main Mix when a channel is assigned to the FlexFx Loop. In this instance, it is possible to add internal or External effects to the signal, and Cue the effected signal in the headphones before switching the **FLEXFX ON** button On.

It is also possible to have the **FLEXFX MIX LEVEL** turned down, **FLEXFX ON** Off, create a submix, add effects (or not) and Cue or rehearse the mix before bringing it into the Main Mix.

This architecture is very flexible and opens up many new possibilities not possible with simple effect insert designs found on other mixers.

## Internal Audio Effects

The internal effects engine is located in the FlexFx Loop. This allows any combination of PGM 1, PGM 2, PGM 3 PGM 4, MIC 1 and MIC 2 to be assigned to an effect. The FlexFx Loop supports recording, cueing and Main Mix level control of an effected signal. This has several advantages over conventional effects assignment.

Note: Individual effects are turned on/off using the effects buttons. The FlexFx Loop which includes the two external inserts) is turned On/Off with the **FLEXFX ON** button (off functions as a loop bypass).

Six built-in effects:

- **FILTER**                      • **FLANGER**                      • **PHASER**
- **HOLD ECHO**                      • **ROBOT**                      • **REVERB**

### General Behavior

- The effect time is saved for each effect.
- Changing BPM for one effect changes the BPM for all effects.
- Tapping the BPM requires at least two taps.
- Changing the Beat multiplier results in an immediate change in the effect time.
- Changing the effect time adjusts the multiplier for other effects so that the new multiplier is as close as possible to the saved effect time.



**Effects Display and Match Indicator**

The effects display shows the current BPM, beat multiplier and time for a selected effect. A bar graph represents the effect time relative to its range. If no effect is selected, the information for the last effect is displayed.



**FLEXFX**

The effect time is normally a product of the BPM and the Beat multiplier.

If the left (<) or right (>) arrow appears, there is an inequality between the BPM\*Beat and time. The arrow indicates which way to adjust the Beat to correct the inequality and get the closest possible time. If an asterisk (\*) is displayed, the BPM\*Beat results in the correct time as displayed.

For example, 120 BPM with a 4/1 beat multiplier would result in an effect time of 2000 ms. If the time is adjusted to a different value, such as 2097 ms, an arrow indicates that the product of the displayed BPM and multiplier does not result in the displayed effect time. For this example, 2000 ms is below 2097 ms, so hitting the < Beat button will snap to 120 \* 4/1 and change the time to its product, 2000 ms.

A flashing bar graph indicates that the requested effect time is out of range.

For example, if a BPM of 120 is used with a beat multiplier of 4, the resulting time is 2 seconds. If the multiplier is set to 16, the resulting time would be 8 seconds, which is out of range. In this case, the time remains at 2 seconds and the bar flashes.

**Effects Synchronization**

The mixer can synchronize its internal effects to songs tagged with BPM values in Serato DJ. With no other channels assigned to the FlexFX, press the FlexFX button in the channel playing a song with a tagged BPM in Serato DJ. The Match Indicator will change to a flashing asterisk (\*) indicating that the mixer is now tracking the Serato DJ supplied BPM, and the internal effect BPM will change to this value. The mixer will continue to track the Serato DJ BPM until a new BPM is manually tapped in using the Tap button.

**Effects Parameter Table**

Effect	Level/Depth Knob	Time Encoder	Tap Button	Beat Buttons
<b>Filter</b>	Adjusts the strength of the effect.	Adjusts the effect time. Holding the Tap Button while turning the knob adjusts the BPM. Depressing the knob restarts the effect. Value range: 32ms – 32000ms	Used to tap in a new BPM, which results in a new effect time.	Adjusts the beat multipliers up or down, which results in a new effect time. Value range: 1/16, 1/8, 1/4, 1/2, 3/4, 1/1, 2/1 4/1, 8/1, 16/1, 32/1, 64/1
<b>Flanger</b>				
<b>Phaser</b>				
<b>Echo</b>	Adjusts the decay of the echo. Max results in no decay, with faster decay the more the knob is turned CCW. Minimum results in no echo.	Adjusts the effect time. The effect time is the length of the recorded sample used for echoing. Holding the Tap Button while twisting the knob adjusts the BPM. Depressing the knob clears out the current sample used for echoing. Value range: 1ms – 4000ms		Adjusts the beat multipliers up or down, which results in a new effect time. Value range: 1/8, 1/4, 1/2, 3/4, 1/1, 2/1 4/1, 8/1, 16/1
<b>Robot</b>	Adjusts the warble.	Adjusts the pitch. Depressing the knob resets the pitch to 0%.	Does not affect Robot.	Adjusts the pitch up or down by 20%.
<b>Reverb</b>	Adjusts reverb depth.	Adjusts the reverb decay time.	Does not affect Reverb.	

## USB Audio

There are six stereo record channels and five stereo playback channels. These channels are simultaneously available on two USB ports, allowing two computers to share the device. This allows two DJs to play together and supports uninterrupted transitions from one DJ to another. The six stereo record channels are sent to both USB ports. The five stereo playback channels from each port are summed in the mixer (playback-1 sums with playback-1 and playback-2 two sums with playback-2 etc.) USB audio is 32-bit floating point with a sample rate of 48 kHz.

Rane ASIO and Core Audio drivers allow the Sixty-Eight to act as a 12-record 10-playback USB sound card for use with Serato DJ and third-party software applications that support ASIO or Core Audio. ASIO and Core Audio drivers are multi-client, meaning they allow multiple applications on a computer to share the device at the same time. ASIO and Core Audio drivers are not available if Scratch Live is running.

The Sixty-Eight has two USB ports, allowing simultaneous connection of two computers. Each port is completely independent. It is possible to run Serato DJ on one port while running third-party software using ASIO or Core Audio on the other, Mac or PC, in any combination.

### Record channels are assigned as follows:

➡ USB-1 Record is assigned to one of these:

- PH / CD 1
  - Pre-source selector
  - Supports Serato Vinyl Control
- AUX 1
- PGM 1 post fader
- 

➡ USB-2 Record is assigned to one of these:

- PH / CD 2
  - Pre-source selector
  - Supports Serato Vinyl Control
- AUX 2
- PGM 2 post fader

➡ USB-3 Record is assigned to one of these:

- PH / CD 3
  - Pre-source selector
  - Supports Serato Vinyl Control
- AUX 3
- PGM 3 post fader

➡ USB-4 Record is assigned to one of these:

- PH / CD 4
  - Pre-source selector
  - Supports Serato Vinyl Control
- AUX 4
- PGM 4 post fader

➡ USB-5 Record is the SEND on the USB-5  
Insert in the FlexFx Loop.

➡ USB-6 Record is assigned to one of these:

- MIC 1
- MIC 2
- Main Mix

### The playback channels are assigned as follows:

➡ USB-1 Playback (Virtual Deck One)

- PGM 1 SOURCE selector
- PGM 2 SOURCE selector

➡ USB-2 Playback (Virtual Deck Two)

- PGM 1 SOURCE selector
- PGM 2 SOURCE selector

➡ USB-3 Playback (Virtual Deck Three)

- PGM 3 SOURCE selector
- PGM 4 SOURCE selector

➡ USB-4 Playback (Virtual Deck Four)

- PGM 3 SOURCE selector
- PGM 4 SOURCE selector

➡ USB-5 Playback is the RETURN on the USB  
Insert in the FlexFx Loop.

**See "DJ Changeover" on page 27.**

**See "Core Audio and ASIO Drivers" on page 20.**

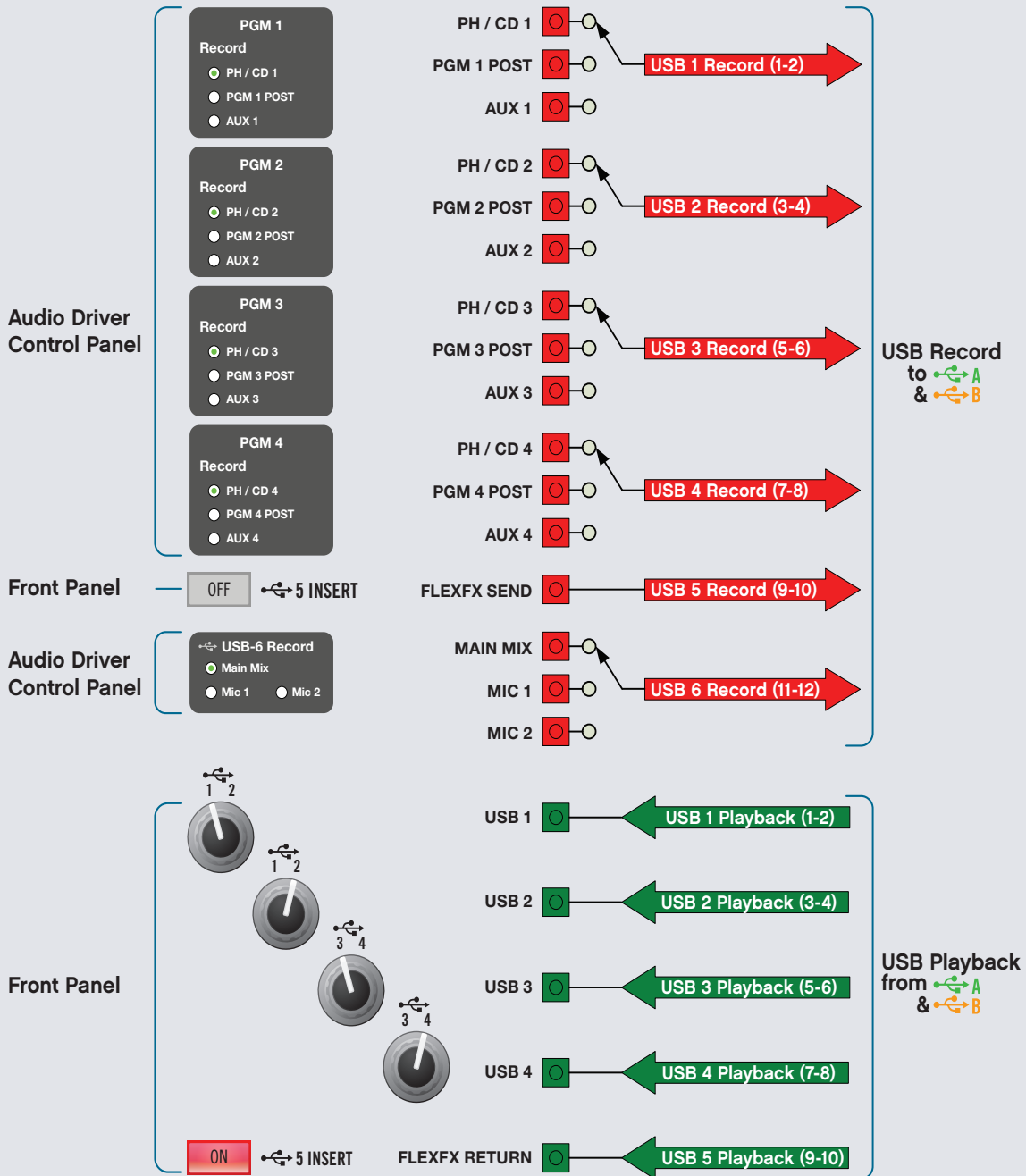

## Core Audio and ASIO Drivers

The Serato DJ installer includes Core Audio (Mac) and ASIO (PC) drivers that allow you to use your Rane Sixty-Eight with other audio applications. Once installed, you will have the option to select the Sixty-Eight's inputs and outputs in the audio settings of other applications. Note: These drivers only work with audio applications that are compatible with these audio standards.

### ASIO (Windows)

The Sixty-Eight uses a low-latency, multi-client, ASIO device driver to interface with software applications on Windows operating systems. Multi-client ASIO allows different audio software applications to simultaneously stream audio to and from the Sixty-Eight. If the same playback channel is selected in more than one application, the driver mixes the audio from the applications before streaming it to the device.

The driver Control Panel may be launched from the Windows Control Panel. Select Start > Control Panel > Rane Sixty-Eight.

### Core Audio (Macintosh)

The Sixty-Eight uses a low-latency Core Audio device driver to interface with software applications on Macintosh operating systems. Core Audio allows different audio software applications to simultaneously stream audio to and from the Sixty-Eight.

To launch the Sixty-Eight driver Control Panel, open the System Preferences window. Locate the Sixty-Eight in the "Other" section and click the Sixty-Eight icon.

### Driver Control Panel

The control Panel consists of three pages, Preferences, PGM 1-4 and MIDI. To move between the three pages, click the Preferences, PGM 1-4 or MIDI  icon in the upper left-hand corner of the control panel.

The **Preferences** page controls the following functions:

- **Headphone Tone:** These Low and High tone controls affect the frequency response of the headphone output so that it may be matched to the headphones in use.
- **USB-6 Record:** The three radio buttons select Main Mix, Mic 1 or Mic 2 as the record source for USB stereo record pair 6 (11-12).
- **Button Backlight:** The two radio buttons allow the user to turn the button backlight off or on. When off, the buttons are not backlit.
- **LCD Contrast:** This control allows adjustment of the LCD display contrast. Contrast is the ratio of character to backlight intensity.
- **Buffer Size:** The Buffer Size control allows the USB driver buffer size to be increased or decreased. The Sixty-Eight drivers are designed to run very reliably at latencies below 8 milliseconds. However, computer performance and available resources (number of applications running) may adversely affect the computer's ability to stream audio reliably. If pops and clicks are heard in the USB audio, try increasing the buffer size to eliminate them. With ASIO, total round-trip latency is equal to Buffer Size plus device latency. With Core Audio, total round-trip latency is equal to Buffer Size plus software application buffer latency, plus device latency. Device latency is 3.1 ms.
- **Firmware Update:** If the Sixty-Eight firmware installed on your computer is newer than the firmware in your Sixty-Eight, the Update Device Firmware panel is enabled. Pressing the Update Firmware button will update the Sixty-Eight firmware to the newer version installed with your driver.

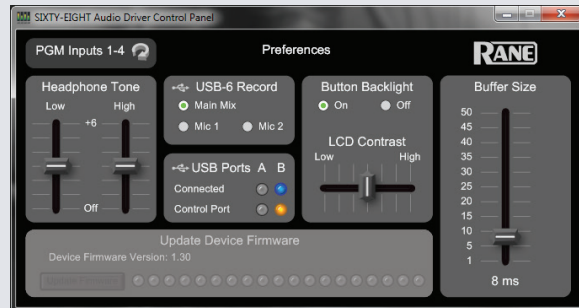

**PGM Inputs 1-4** have one panel for each channel strip on the mixer. Each PGM panel controls the following functions:

- **Analog Input Source:** The analog input for each channel may be set for Line-level (CD), Phono-level or S/PDIF using a dip switch on the rear of the mixer. The control panel shows the input mode selected on the mixer. The mode cannot be changed from the control panel.
- **Phono Sensitivity:** If Phono Input is selected on the mixer, the Phono sensitivity control appears as shown in the PGM 3 and 4 panels above. Clicking the down-arrow displays a list of 16 sensitivity settings between 2.5 mV and 10 mV in 0.5 mV steps. Choose the setting that most closely matches the level of a CD input, or to the setting that provides the highest output without clipping.
- **Filter Resonance:** Each channel of the Sixty-Eight has a filter knob that provides both High- and Low-Cut filtering. Filter resonance controls how “peaky” the gain is at the filter cutoff frequency. The Low setting provides the smoothest filter without adding gain. The High setting adds accent to frequencies near the filter cutoff point by adding about 5 dB of gain. Adding gain in a narrow region around the cutoff frequency adds a “zipper” noise to audio as the filter is swept.
- **Record Source:** This control allows selecting the record source for USB record pairs 1-4. Serato DJ uses PH/CD for the control signal. If Serato DJ is used for DVS, the record source must remain PH/CD for any input providing a vinyl control signal. PGM Post and AUX selections are available to support multi-channel recording when using third-party software applications.

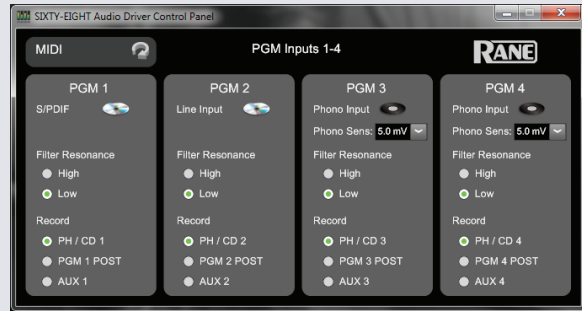

The **MIDI Channel Selection** page allows selection of input and output MIDI channels. MIDI In and MIDI Out may be set to any channel between one and sixteen or OFF. If MIDI in or out are not being used, set them to **OFF**. MIDI Out defaults to channel **1** and MIDI In defaults to **OFF**.



## MIDI Mapping

It is possible to MIDI-map most mixer controls on the Sixty-Eight and control the color of buttons in the software control strips. The following graphics show **MIDI Out** “Note ON/OFF” and “Control Change” assignments.

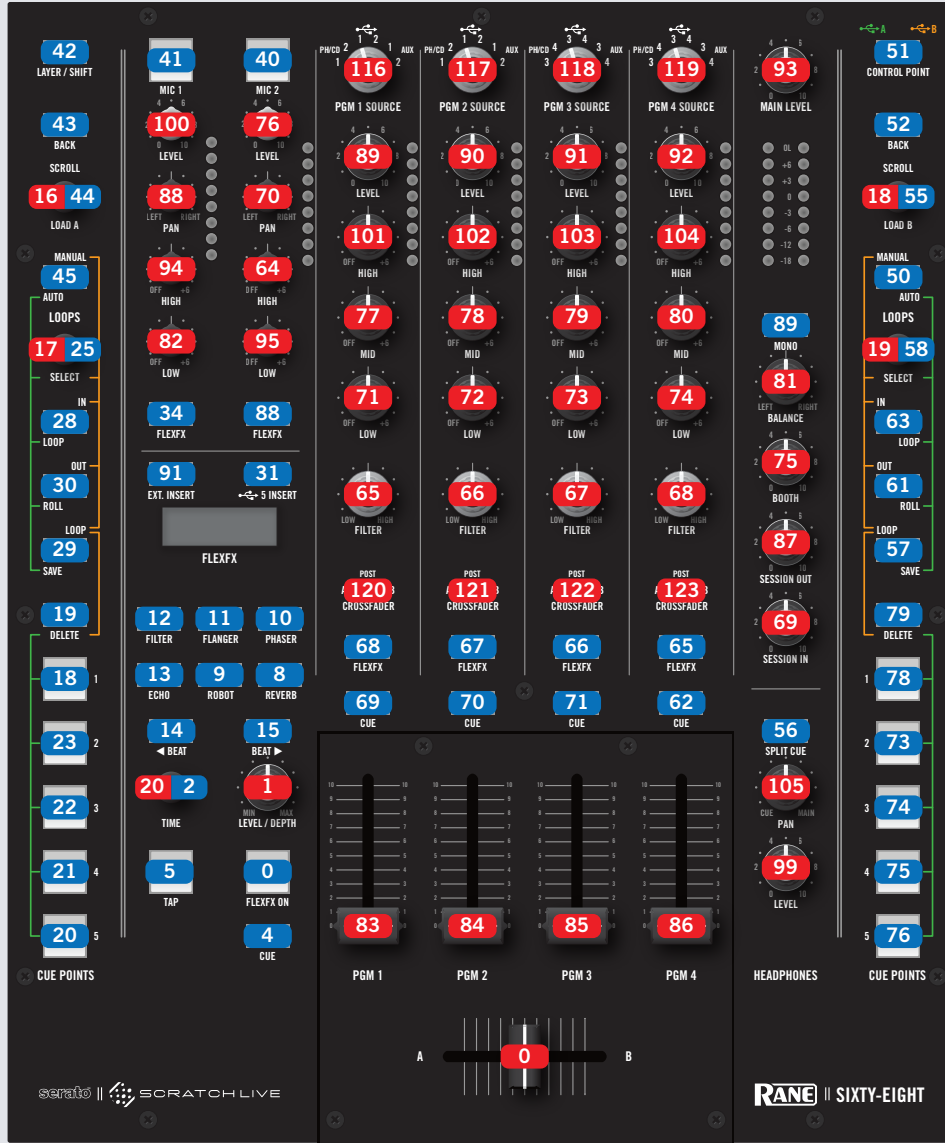

Control Change

Note On / Off



Control Change

MIDI In Assignments

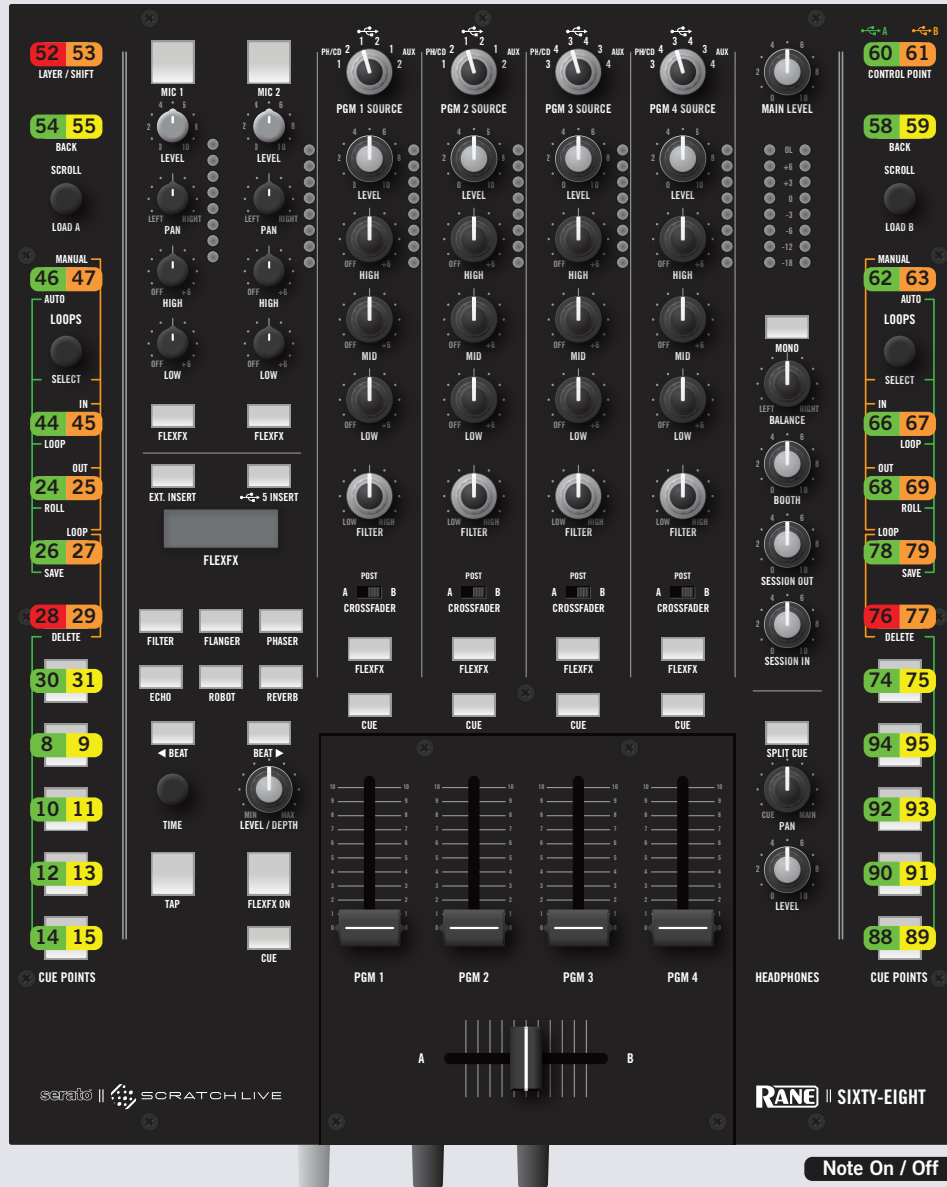

MIDI in “Note On/Off” for button lighting: (fill color indicates the LED color for the corresponding number).

- Note on with a velocity of 127: a Bright LED
- Note on with a velocity of 64: a DIM LED
- Note on with a velocity of 0: an LED Off
- Note off: an LED off

**MIDI in “Control Change” assignments for the driver control panels.**

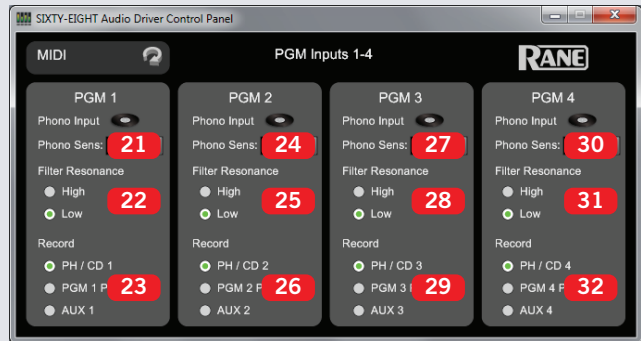
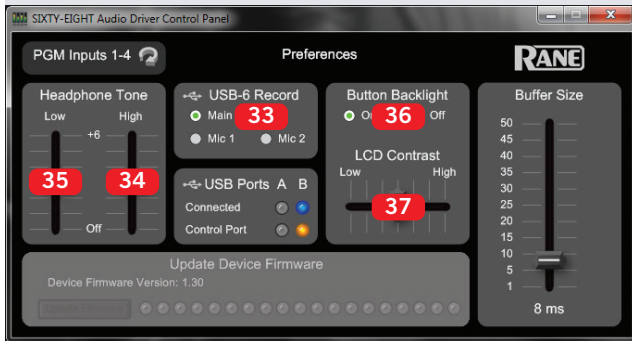

**Control Change**

Control Change format is shown in the following tables.

**Control Change Input to the Device:**

Parameter Description	Control Number	Values
PGM 1 Phono Sensitivity	21	Value    Sens. (mV)    dB
		0            2.5            12.04
		1            3                10.46
		2            3.5             9.12
		3            4                7.96
		4            4.5             6.94
		5 (Default) 5            6.02
		6            5.5             5.19
		7            6                4.44
		8            6.5             3.74
		9            7                3.10
		10           7.5             2.5
		11           8                1.94
		12           8.5             1.41
		13           9                0.92
		14           9.5             0.45
		15           10              0.00
PGM 1 Filter Resonance	22	0-64: Low 65-127: High
PGM 1 Record Select	23	1: Record PH/CD 1 2: Record PGM 1 Post 3: Record Aux 1
PGM 2 Phono Sensitivity	24	Same as PGM 1 Phono Sensitivity
PGM 2 Filter Resonance	25	0-64: Low 65-127: High
PGM 2 Record Select	26	1: Record PH/CD 2 2: Record PGM 2 Post 3: Record Aux 2



PGM 3 Phono Sensitivity	27	Same as PGM 1 Phono Sensitivity
PGM 3 Filter Resonance	28	0-64: Low 65-127: High
PGM 3 Record Select	29	1: Record PH/CD 2 2: Record PGM 2 Post 3: Record Aux 2
PGM 4 Phono Sensitivity	30	Same as PGM 1 Phono Sensitivity
PGM 4 Filter Resonance	31	0-64: Low 65-127: High
PGM 4 Record Select	32	1: Record PH/CD 2 2: Record PGM 2 Post 3: Record Aux 2
Main Record Select	35	1: Record Main Mix 2: Record Mic 1 3: Record Mic 2
Phones Tone High	36	0-127 (64=flat)
Phones Tone Low	37	0-127 (64=flat)
Backlight	38	0: Off 1: On

**Control Change Output from the Device:**

All knobs and sliders are 0-127. This table lists special control changes:

Brief Description	Control Number	Values
PGM 1 Source	116	1: PH/CD 1 2: PH/CD 2 3: USB 1 4: USB 2 5: AUX 1 6: AUX 2
PGM 2 Source	117	1: PH/CD 1 2: PH/CD 2 3: USB 1 4: USB 2 5: AUX 1 6: AUX 2
PGM 3 Source	118	1: PH/CD 3 2: PH/CD 4 3: USB 3 4: USB 4 5: AUX 3 6: AUX 4
PGM 4 Source	119	1: PH/CD 3 2: PH/CD 4 3: USB 3 4: USB 4 5: AUX 3 6: AUX 4

PGM 1 Crossfader Select	120	1: Crossfader A 2: Crossfader B 3: Post-Crossfader
PGM 2 Crossfader Select	121	1: Crossfader A 2: Crossfader B 3: Post-Crossfader
PGM 3 Crossfader Select	122	1: Crossfader A 2: Crossfader B 3: Post-Crossfader
PGM 4 Crossfader Select	123	1: Crossfader A 2: Crossfader B 3: Post-Crossfader
PGM 1 Input Select	112	1: PHONO 2: SPDIF 3: LINE
PGM 2 Input Select	113	1: PHONO 2: SPDIF 3: LINE
PGM 3 Input Select	114	1: PHONO 2: SPDIF 3: LINE
PGM 4 Input Select	115	1: PHONO 2: SPDIF 3: LINE
Encoders	16 17 18 19	Encode value is biased by 64. 3-clicks clockwise = $64+3 = 67$ . 2-clicks counter clockwise = $64-2 = 62$ .

## DJ Changeover

The Sixty-Eight allows two computers to connect to the mixer simultaneously. This allows two DJs to play at the same time and for easy DJ changeover.

Connect both computers to the two USB ports on the Sixty-Eight. On each computer, select a USB Source for each Virtual Deck. For any Virtual Decks on either computer that aren't to be used, set the USB Source to None.

**NOTE: If you can't select a particular USB source for a Deck, make sure it is not already set on another computer or Virtual Deck. Each USB Source can only be set to one virtual deck on one computer at a time. When two computers are connected, you can use up to 4 USB sources in total.**

Press the **CONTROL POINT** button on the Sixty-Eight to select which computer is controlled by the Sixty-Eight's control Strips.

- Computer A = orange.
- Computer B = green.

### The DJ Changeover Walkthrough

Swapping between two DJs both using Serato DJ is now easier than ever! With a computer already connected to the Sixty-Eight and playing, do the following:

1. Connect the second computer to the unused USB port on the Sixty-Eight.
- 2a. **Using Four Control Sources:** Select a USB Source for a Virtual Deck that is not already being used on the first computer. If the first DJ is using all four USB sources, you will need to politely ask them to free up at least one channel for you to take over.
- 2b. **Using Two Control Sources:** Unassign the USB Source for the non-playing Virtual Deck on Computer A. Then have Computer B assign that same USB Source to one of its Virtual Decks.
3. Play a track on this Deck and mix it in when ready — you'll now have audio from both computers in the mix.
4. Fade out the audio playing from the first computer to the audio playing from the second computer.
5. When only audio from the second computer is left in the mix, remove the first computer.
6. Assign USB sources for the remaining Virtual Decks on the second computer and continue DJing.

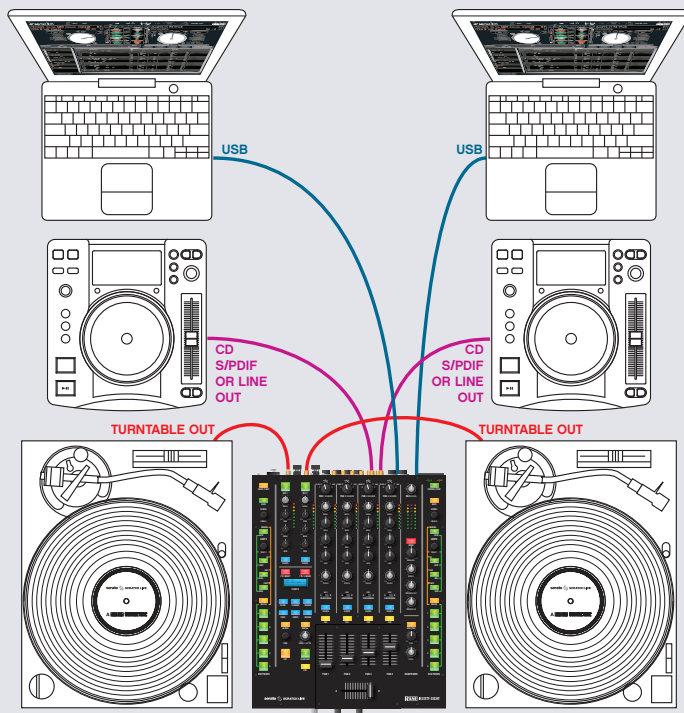

## Technical Specifications

Specifications	All specifications typical unless otherwise stated
Analog Inputs	4 Stereo unbalanced RCA jacks
.....Phono, Line level or S/PDIF input	Rear panel switches for each input
.....Phono Response	RIAA $\pm 1$ dB, Gain: 35 dB at 1 kHz
.....Max Phono Input	115 mV
.....Max Line Input	4 Vrms
S/PDIF Inputs	16-bit or 24-bit PCM only
.....SRC Output	Always 24-bit
.....Input Sample Rate	16 kHz to 144 kHz
.....SRC Output Sample Rate	Always 48 kHz
ADCs	24-bit, 48 kHz; Dynamic range 101 dB A-weighted
DACs	24-bit, 48 kHz; Dynamic range 107 dB A-weighted
Digital Signal Processing	48 kHz, 32-bit floating point
USB Audio	Six Stereo Record, Five Stereo Playback
.....	48 kHz, 32-bit floating point
FlexFX Return	Stereo unbalanced 1/4" TS (tip-sleeve) phone jack
FlexFX Send	Stereo unbalanced 1/4" TS phone jack
Mic Inputs	Balanced 1/4" TRS & XLR combination jack
.....Tone Controls	2-band, High and Low
.....Mic 1	+48V Phantom Power on/off switch
.....Mic 2	Mic/Line-level switch
Line Outputs: Frequency Response	20 Hz to 20 kHz $\pm 0.25$ dB, Line in to Line out
.....THD+N	<0.01% re 0 dBFS, 20 to 20 kHz, 20 kHz BW
.....Unbalanced jacks (RCA & FlexFX)	Maximum 4 Vrms
.....Balanced jacks (Main & Booth)	Maximum 8 Vrms
Universal Power Supply	100 to 240 VAC, 50 Hz to 60 Hz, 15 W max
USB Power	Mixer is self-powered
Unit Size	14.3" H x 12" W x 4" D (36.4 cm x 30.5 cm x 10.2 cm)
.....Weight	11.3 lb (5.2 kg)
Shipping Size	7.75" H x 15" W x 19.25" D (19.7 cm x 38.1 cm x 49 cm)
.....Weight	16 lb (7.26 kg)

ADD 3.5" (8.9 cm) MINIMUM CLEARANCE FOR CABLES

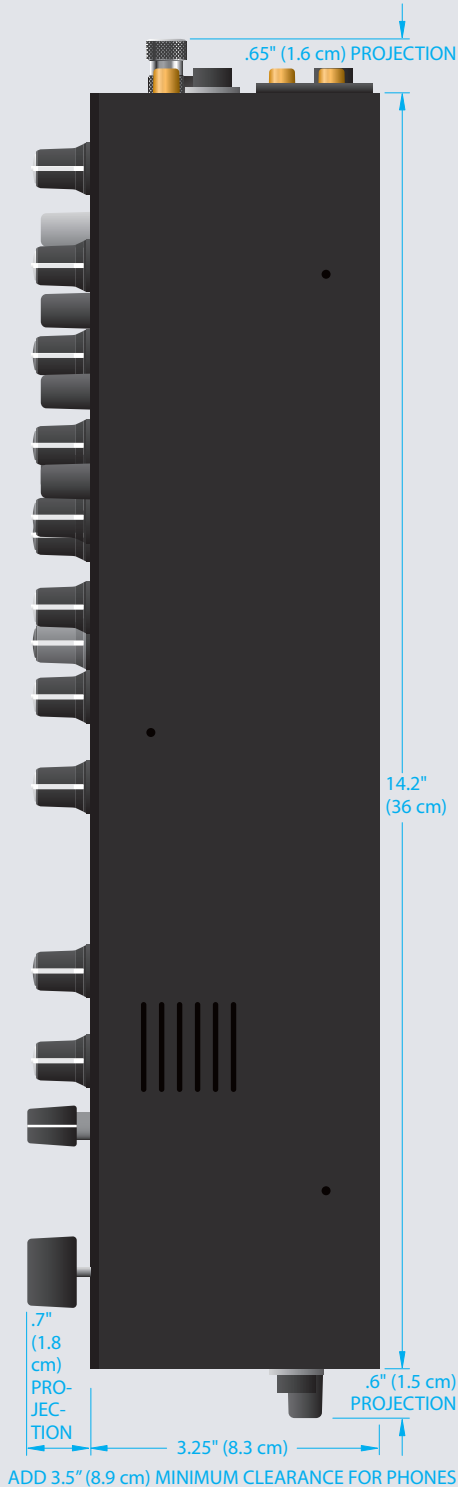

## Mounting Bracket Accessories

When installing a Sixty-Eight mixer in a coffin case, it is important to leave 3.9 inches (10 cm) in front and in back of the mixer to allow room for cables and access to controls. The rubber feet provided on the chassis for table top use should remain in place when installing the mixer in a coffin case. When in operation, the coffin case setup must provide 0.39 inches (1 cm) clearance on each side of the mixer and above the controls on the face of the mixer.

Two mounting bracket kits are available for the Sixty-Eight Mixer. Brackets install easily with three screws on each side. These are powder-coated .075" steel, matching the paint of the mixer.

Diagrams and placement are shown on the next page.

**14" EARS** bring the total width of the mixer to 13.3" (33.78 cm) for coffin mounting. These measure 14" x .75" x 3" (35.8 x 1.9 x 7.7 cm). Shipping weight is 3 pounds (1.36 kg).

**19" EARS** bring the total width of the mixer to 19" (48.26 cm) for rack mounting. These measure 14" x 3.6" x 3" (35.8 x 9.2 x 7.7 cm). Shipping weight is 5 pounds (2.27 kg).

If you live in the U.S.A, you may buy these ears in the Rane Factory Store at [dj.rane.com](http://dj.rane.com). Outside the U.S.A, contact your international representative, contact information is at [dj.rane.com](http://dj.rane.com).

### CASE4 ROAD CASE

The model CASE4 is designed to fit the Sixty-Eight Mixer. This case is made from high impact NK-7 resin designed to absorb the shocks of transport. While being watertight, it is equipped with an automatic pressure release valve to equalize pressure inside the case. There's added space beneath the mixer for cables, phono cartridges and other small items. The case measures 7.5" x 16" x 19.75" (19 x 41 x 50 cm). Shipping weight is 17 pounds (7.72 kg), unboxed and empty is 10 pounds (4.53 kg).

In the U.S.A, you may buy the CASE4 in the Rane Factory Store at [rane.com](http://rane.com). Outside the U.S.A, contact your representative, their info is at [rane.com](http://rane.com).

# OWNER'S MANUAL

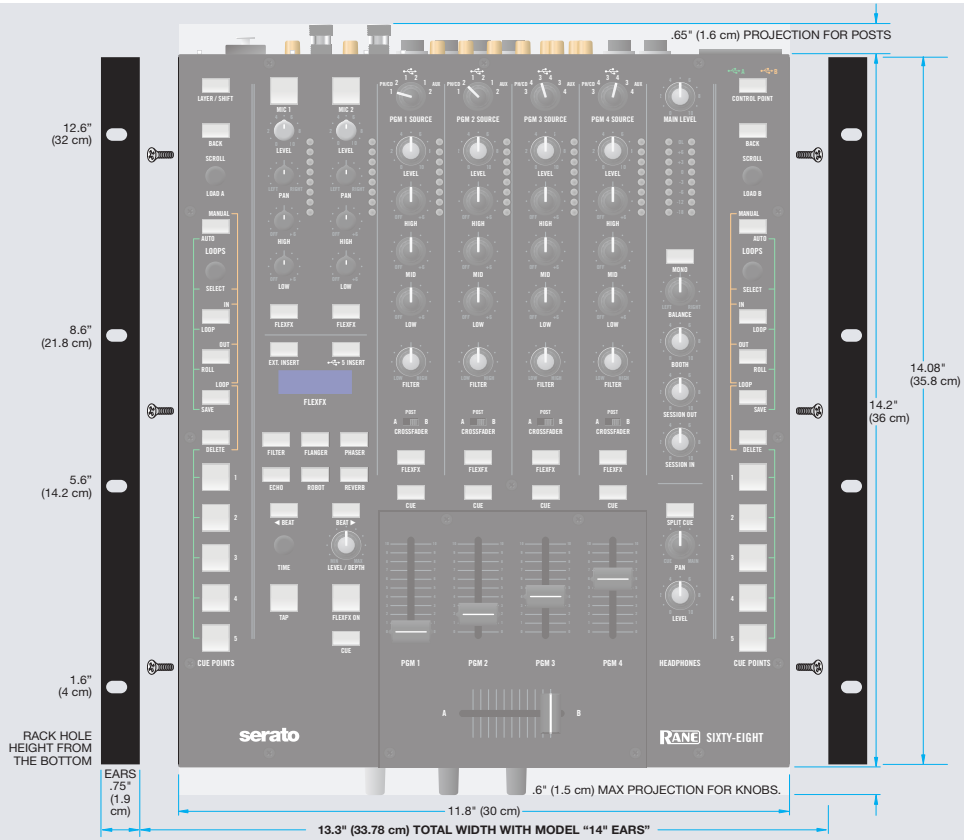

WHEN RACKMOUNTING, ADD AT LEAST TWO RACK SPACES ABOVE FOR CABLE CLEARANCE

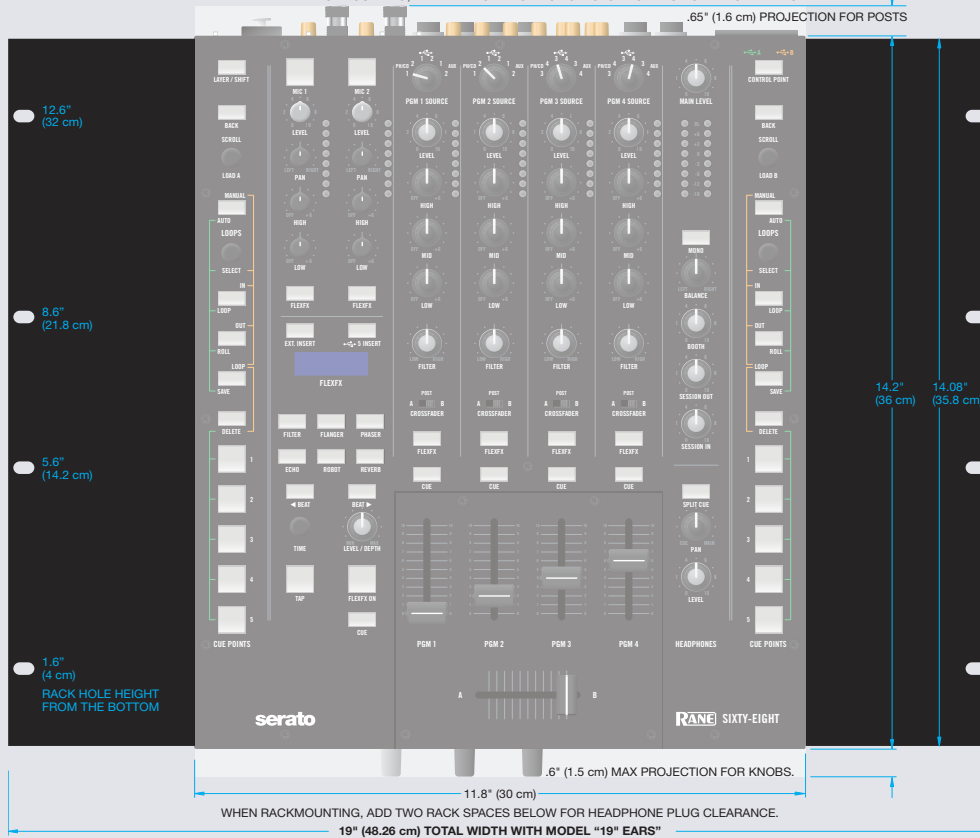

**RANE**

**SIXTY-EIGHT**

## Fader Maintenance

The crossfader in the Sixty-Eight is designed with materials highly resistant to corrosion and most chemicals. While it will handle millions of operations, it may become dirty over time. Bad things may be spilled into the crossfader, but in many instances the crossfader may not be damaged and the sound quality thus unaffected. Cleaning is only required to maintain the feel of the crossfader.

In order to maintain the feel of your crossfader, it may occasionally require cleaning and lubrication. The bearings in the fader work best with DuPont Teflon Multi-use Lubricant (part # D00040101). Make sure to follow the instructions and warnings on the bottle.

This lubricant goes on wet to deeply penetrate moving parts, but sets up with a clean, dry, long-lasting film which will not attract and absorb dirt and grime. Wet or oily lubricants may feel good at first, but will attract dirt and evaporate or become dry over time. See the crossfader cleaning instructions.

### Magnetic Crossfader Cleaning

1. For a light cleaning, move the carrier to one side and wipe rails with a lint-free cloth. Move the carrier to the other side and repeat.
2. If a heavier cleaning is required to remove oily lubricants, first take the carrier off of the rails by removing one of the endblocks. Clean the rails using a lint-free cloth and alcohol. Use a cue-tip and alcohol to clean the carrier bearings.
3. With the fader clean, dry and assembled, add a couple of drops of Teflon Multi-use Lubricant to each rail of the fader.
4. Move the carrier back and forth to distribute lubricant.
5. Do not disturb the position of the small sensors at each end of the fader. If you accidentally do, make sure the parts are standing straight before re-installing.
6. Problems? Contact Rane Corporation customer service at 425-355-6000 or email us at [info@rane.com](mailto:info@rane.com).

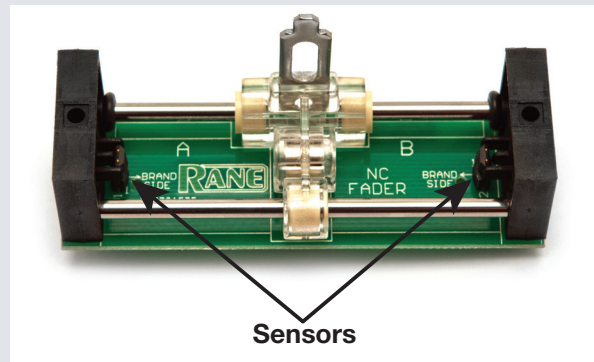

### Channel Fader Cleaning

With heavy use in harsh environments, the channel faders may need lubrication. This treatment extends longevity and can make used faders as good as new. The fader assembly must be removed from the Sixty-Eight for proper cleaning. We recommend any of the following cleaning solutions:

- Caig DeoxIT FaderLube F100 spray lubricant.
- Caig DeoxIT FaderLube F5 spray cleaner.
- CRC 2-26 ([www.crcindustries.com](http://www.crcindustries.com)).

Order CaiLube MCL® from CAIG Laboratories, Inc.  
12200 Thatcher Ct., Poway, CA 92064  
Phone is 858-486-8388. Web is [www.caig.com](http://www.caig.com).

- A. Hold the fader assembly away from the mixer.
- B. Position the fader at mid-travel.
- C. Spray cleaner/lubricant into both ends of the fader.
- D. Move the fader over its full travel back and forth a few times.
- E. Shake excess fluid from the fader assembly.
- F. Wipe off excess fluid.

**Fader Assembly Removal**

- ① Remove all five fader knobs.
- ② Remove all four screws holding the fader panel face plate.
- ③ Lift up the fader panel face plate and set it aside where it can't get damaged.
- ④ Remove the two screws in the main panel at the top of the fader assembly.
- ⑤ Remove the two screws at the front of the fader assembly.
- ⑥ Slide the fader assembly out just enough to see the three white and blue wires and their connectors.
- ⑦ Unplug the connectors of the three white and blue wires.
- ⑧ Slide out the fader assembly completely.
- ⑨ The channel faders are mounted in pairs. Remove the four screws for each pair of faders (1 and 2) or (3 and 4).
- ⑩ The magnetic crossfader may be removed by the two screws at each end of the crossfader.

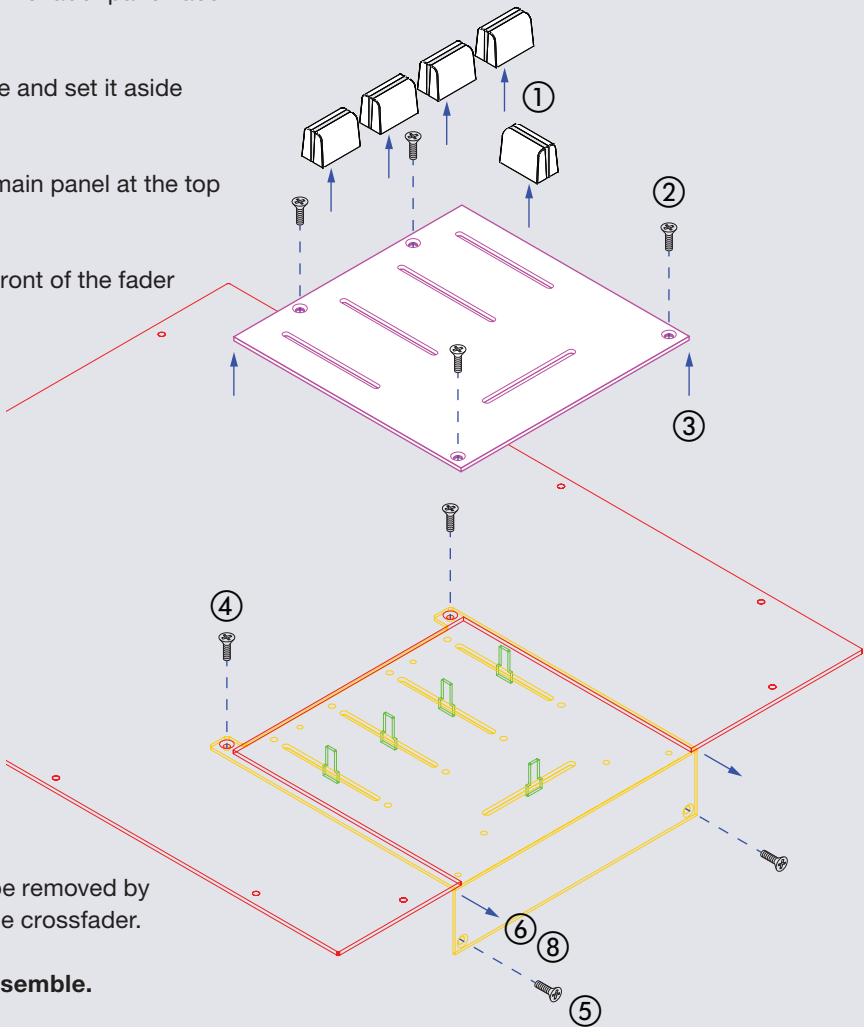

**Reverse this procedure to re-assemble.**

- Plug in all three cables before installing screws.
- Confirm cables are not crossed, with faders 1 & 2 on the left connector, faders 3 & 4 on the right connector, and the blue crossfader wires in the center.
- Test all the faders before installing the fader panel face plate and fader knobs.

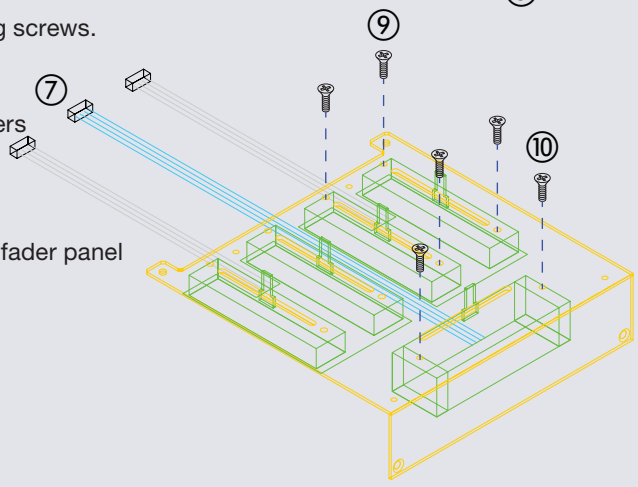



# Signal Processing Block Diagram

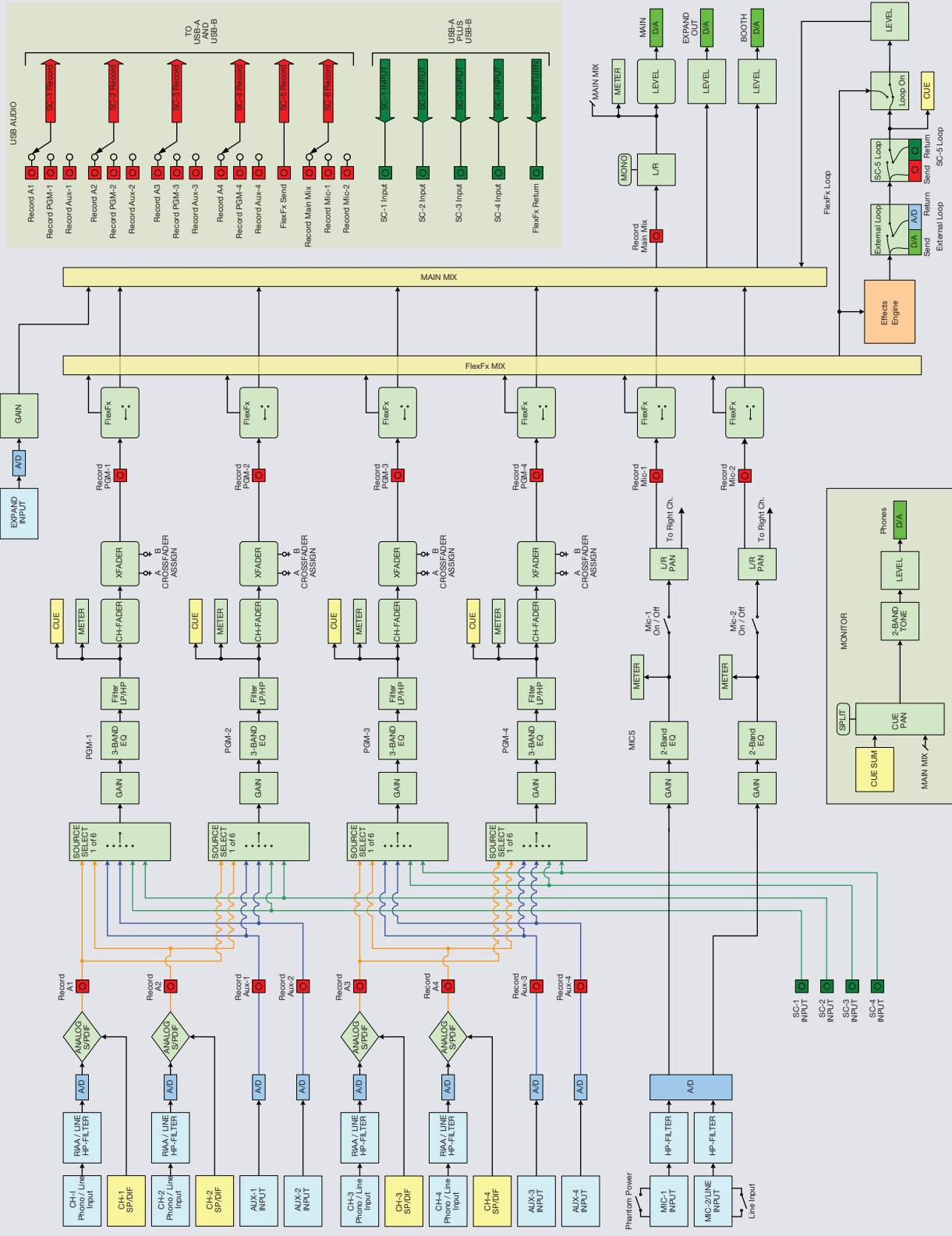

## Declaration of Conformity

**Application of Council Directive:**

2001/95/EC      2002/96/EC  
 2004/108/EC    2006/95/EC  
 2011/65/EU

**Standard(s) to which conformity is declared:**

EN60065:2002/A1:2006/A11:2008  
 EN55103-1:2009  
 EN55103-2:2009  
 EN50581:2012  
 ENVIRONMENT E2  
 SERIAL NUMBERS 850000-950000  
 CE MARK FIRST AFFIXED IN: 2010

**Manufacturer:**

- Rane Corporation
- 10802 47th Avenue West
- Mukilteo WA 98275-5000 USA

This equipment has been tested and found to be in compliance with all applicable standards and regulations applying to the EU's Low Voltage (LV) directive 2006/95/EC and Electromagnetic Compatibility (EMC) directive, 2004/108/EC. In order for the customer to maintain compliance with this regulation, high quality shielded cable must be used for interconnection to other equipment. Modification of the equipment, other than that expressly outlined by the manufacturer, is not allowed under this directive. The user of this equipment shall accept full responsibility for compliance with the LV directive and the EMC directive in the event that the equipment is modified without written consent of the manufacturer. This declaration of conformity is issued under the sole responsibility of Rane Corporation.

**Type of Equipment:** Professional Audio Signal Processing

**Brand:** Rane

**Model:** Sixty-Eight

Immunity Results:

THD+N: 4 dBu, 400 Hz, BW 20 Hz - 20 kHz

Test Description	Measurement	Conditions
<b>RF Electromagnetic Fields Immunity</b>		
80 MHz -1000 MHz, 1 kHz AM, 80% depth, 3V/m	<-75 dB	80 MHz - 87.4 MHz
	<-70 dB	87.4 MHz - 92.8 MHz
	<-75 dB	92.8 MHz - 126 MHz
	<-60 dB	126 MHz - 132 MHz
	<-75 dB	132 MHz - 1000 MHz
<b>Conducted RF Disturbances Immunity</b>		
150 kHz - 80 MHz, 1 kHz AM, 80% depth, 3V rms	<-75 dB	150 kHz - 4.0 MHz
	<-74 dB	4.0 MHz - 4.18 MHz
	<-65 dB	4.18 MHz - 4.25 MHz
	<-75 dB	4.25 MHz - 80 MHz
<b>Magnetic Fields Immunity</b>		
50 Hz - 10 kHz, 3.0 - 0.3 A/m	<-74 dB	
<b>Common Mode Immunity (Signal Ports)</b>		
50 Hz - 10 kHz, -20 dBu	<-47 dB	Bandpass re: 4 dBu, 1/3-octave

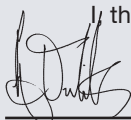

(Signature)

the undersigned, hereby declare that the equipment specified above conforms to the Directive(s) and Standard(s) shown above.

**Greg Frederick**  
 (Full Name)

**Compliance Engineer**  
 (Position)

**March 1, 2010**  
 (Date)

**Mukilteo WA USA**  
 (Place)

## Limited Warranties

### Factory Authorized Service

Your unit may someday need to be serviced by the Rane Factory if you live in the USA. International customers should contact your dealer or distributor for service. You must call the Rane factory before shipping. Please do not return your unit to Rane without prior authorization.

To obtain service or a Return Authorization in the USA, please phone Rane Corporation at 425-355-6000, or fax Rane at 425-347-7757.

### Limited U.S.A. Warranty

RANE CORPORATION WARRANTS ALL RANE PRODUCTS (except those items classified and listed in "Wear Parts" on page 3) PURCHASED IN THE U.S. AGAINST DEFECTS IN MATERIAL OR WORKMANSHIP FOR A PERIOD OF TWO (2) YEARS. WEAR PARTS ARE LIMITED TO A PERIOD OF NINETY (90) DAYS FROM THE INITIAL DATE OF RETAIL PURCHASE FROM AN AUTHORIZED RANE DEALER—WEAR PARTS REQUIRE PROOF OF PURCHASE DATE. This limited warranty extends to all purchasers or owners of the product during the warranty period beginning with the original retail purchase. Rane Corporation does not, however, warrant its products against any and all defects: 1) arising out of material or workmanship not provided or furnished by Rane, or 2) resulting from abnormal use of the product or use in violation of instructions, or 3) in products repaired or serviced by other than the Rane Factory, or 4) in products with removed or defaced serial numbers, or 5) in components or parts or products expressly warranted by another manufacturer. Rane agrees to supply all parts and labor to repair or replace defects covered by this limited warranty with parts or products of original or improved design, at its option in each respect, if the defective product is shipped prior to the end of the warranty period to the Rane Factory in the original packaging or a replacement supplied by Rane, with all transportation costs and full insurance paid each way by the purchaser or owner.

### Limited Warranty Outside the U.S.A.

RANE PRODUCTS ARE WARRANTED ONLY IN THE COUNTRY WHERE PURCHASED, THROUGH THE AUTHORIZED RANE DISTRIBUTOR IN THAT COUNTRY, AGAINST DEFECTS IN MATERIAL OR WORKMANSHIP, THE SPECIFIC PERIOD OF THIS LIMITED WARRANTY SHALL BE THAT WHICH IS DESCRIBED TO THE ORIGINAL RETAIL PURCHASER BY THE AUTHORIZED RANE DEALER OR DISTRIBUTOR AT THE TIME OF PURCHASE. Rane Corporation does not, however, warrant its products against any and all defects: 1) arising out of materials or workmanship not provided or furnished by Rane, or 2) resulting from abnormal use of the product or use in violation of instructions, or 3) in products repaired or serviced by other than authorized Rane repair facilities, or 4) in products with removed or defaced serial numbers, or 5) in components or parts or products expressly warranted by another manufacturer. Rane agrees, through the applicable authorized distributor, to repair or replace defects covered by this limited warranty with parts or products of original or improved design, at its option in each respect, if the defective product is shipped prior to the end of the warranty period to the designated authorized Rane warranty repair facility in the country where purchased, or to the Rane factory in the U.S., in the original packaging or a replacement supplied by Rane, with all transportation costs and full insurance paid each way by the purchaser or owner.

ALL REMEDIES AND THE MEASURE OF DAMAGES ARE LIMITED TO THE ABOVE SERVICES, IT IS POSSIBLE THAT ECONOMIC LOSS OR INJURY TO PERSON OR PROPERTY MAY RESULT FROM THE FAILURE OF THE PRODUCT; HOWEVER, EVEN IF RANE HAS BEEN ADVISED OF THIS POSSIBILITY, THIS LIMITED WARRANTY DOES NOT COVER ANY SUCH CONSEQUENTIAL OR INCIDENTAL DAMAGES. SOME STATES OR COUNTRIES DO NOT ALLOW THE LIMITATIONS OR EXCLUSION OF INCIDENTAL OR CONSEQUENTIAL DAMAGES, SO THE ABOVE LIMITATION MAY NOT APPLY TO YOU.

ANY AND ALL WARRANTIES, EXPRESS OR IMPLIED, ARISING BY LAW, COURSE OF DEALING, COURSE OF PERFORMANCE, USAGE OF TRADE, OR OTHERWISE, INCLUDING BUT NOT LIMITED TO IMPLIED WARRANTIES OF MERCHANTABILITY AND FITNESS FOR A PARTICULAR PURPOSE, ARE LIMITED TO A PERIOD OF TWO (2) YEARS FROM EITHER THE DATE OF ORIGINAL RETAIL PURCHASE OR, IN THE EVENT NO PROOF OF PURCHASE DATE IS AVAILABLE, THE DATE OF MANUFACTURE, SOME STATES OR COUNTRIES DO NOT ALLOW LIMITATIONS ON HOW LONG AN IMPLIED WARRANTY LASTS, SO THE ABOVE LIMITATIONS MAY NOT APPLY TO YOU. THIS LIMITED WARRANTY GIVES YOU SPECIFIC LEGAL RIGHTS, AND YOU MAY ALSO HAVE OTHER RIGHTS WHICH VARY FROM STATE TO STATE, COUNTRY TO COUNTRY.

## Warranty Procedure - Valid in U.S.A. only

**NOTICE! You must complete and return the warranty card or register your product online to extend the Warranty from 2 years to 3 years!**

TO VALIDATE YOUR EXTENDED WARRANTY: Use the postcard that came in the box with your unit, or go to the **support** page at [dj.rane.com](http://dj.rane.com) and click on **product registration**. Fill out the warranty completely, being sure to include the model and serial number of the unit since this is how warranties are tracked. If your Rane product was purchased in the U.S.A., mail the completed card or register online with to Rane Corporation within 10 days from the date of purchase. **If you purchased the product outside the U.S.A. you must file your warranty registration with the Rane Distributor in that country.** It is advised that you keep your bill of sale as proof of purchase, should any difficulties arise concerning the registration of the warranty card. **NOTICE: IT IS NOT NECESSARY TO REGISTER IN ORDER TO RECEIVE RANE CORPORATION'S STANDARD TWO YEAR LIMITED WARRANTY.**

WARRANTY REGISTRATION is made and tracked by MODEL AND SERIAL NUMBERS ONLY, not by the purchaser's or owner's name. Therefore any warranty correspondence or inquires **MUST** include the model and serial number of the product in question. Be sure to fill in the model and serial number in the space provided below and keep this in a safe place for future reference.

WARRANTY SERVICE MUST BE PERFORMED ONLY BY AN AUTHORIZED RANE SERVICE FACILITY LOCATED IN THE COUNTRY WHERE THE UNIT WAS PURCHASED, OR (if product was purchased in the U.S.) AT THE RANE FACTORY IN THE U.S.. If the product is being sent to Rane for repair, please call the factory for a Return Authorization number. We recommend advance notice be given to the repair facility to avoid possible needless shipment in case the problem can be solved over the phone. **UNAUTHORIZED SERVICE PERFORMED ON ANY RANE PRODUCT WILL VOID ITS EXISTING FACTORY WARRANTY.**

FACTORY SERVICE: If you wish your Rane product to be serviced at the factory, it must be shipped **FULLY INSURED, IN THE ORIGINAL PACKING OR EQUIVALENT**. This warranty will **NOT** cover repairs on products damaged through improper packaging. If possible, avoid sending products through the mail. Be sure to include in the package:

1. Complete return street shipping address (P.O. Box numbers are **NOT** acceptable).
2. A detailed description of any problems experienced, including the make and model numbers of any other system equipment.
3. Remote power supply, if applicable.

Repaired products purchased in the U.S. will be returned prepaid freight via the same method they were sent to Rane. Products purchased in the U.S., but sent to the factory from outside the U.S. **MUST** include return freight funds, and the sender is fully responsible for all customs procedures, duties, tariffs and deposits.

**In order to qualify for Rane's one year extended warranty (for a total of 3 years parts and labor), the warranty must be completely filled out and sent to us immediately. Valid in USA only.**

**We recommend you write your serial number here in your owners manual and on your sales receipt for your records.**

SERIAL NUMBER: \_\_\_\_\_ PURCHASE DATE: \_\_\_\_\_

**[dj.rane.com](http://dj.rane.com) is your center for support, accessories, community, and learning how to get the most from your Sixty-Eight Mixer.**